



Installation Instructions

Kota 24

Verification number:

K24 Wall Plan

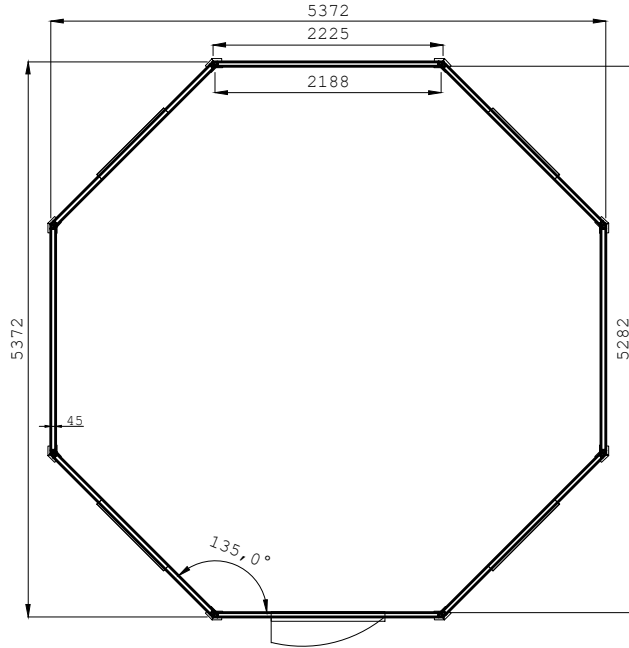

K24 Basement Plan

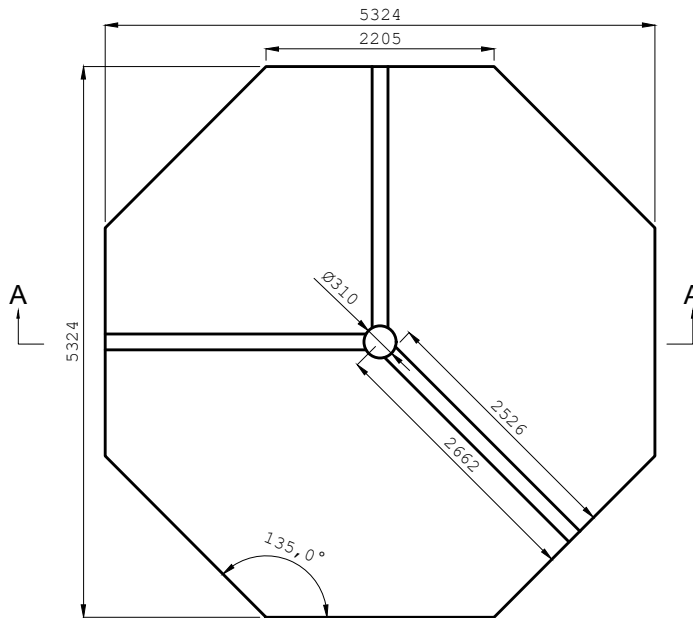

A - A

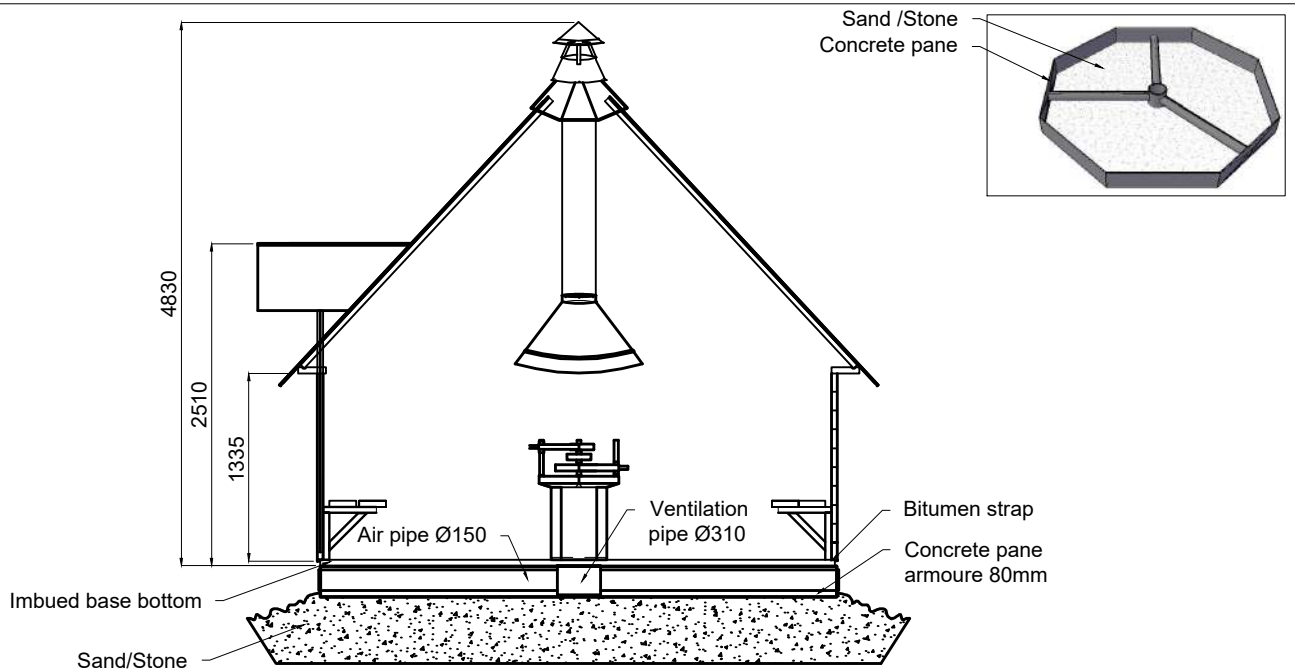

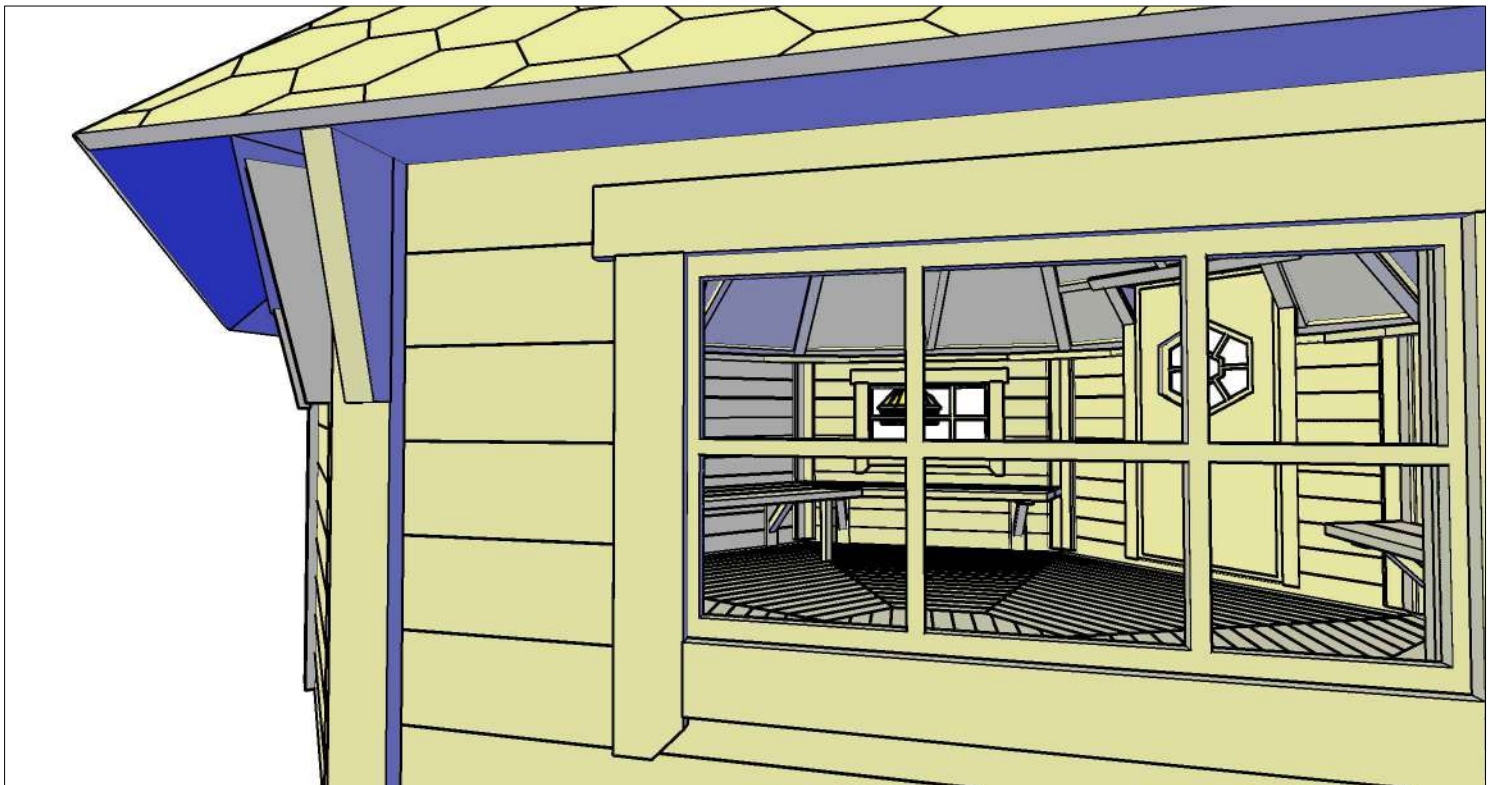
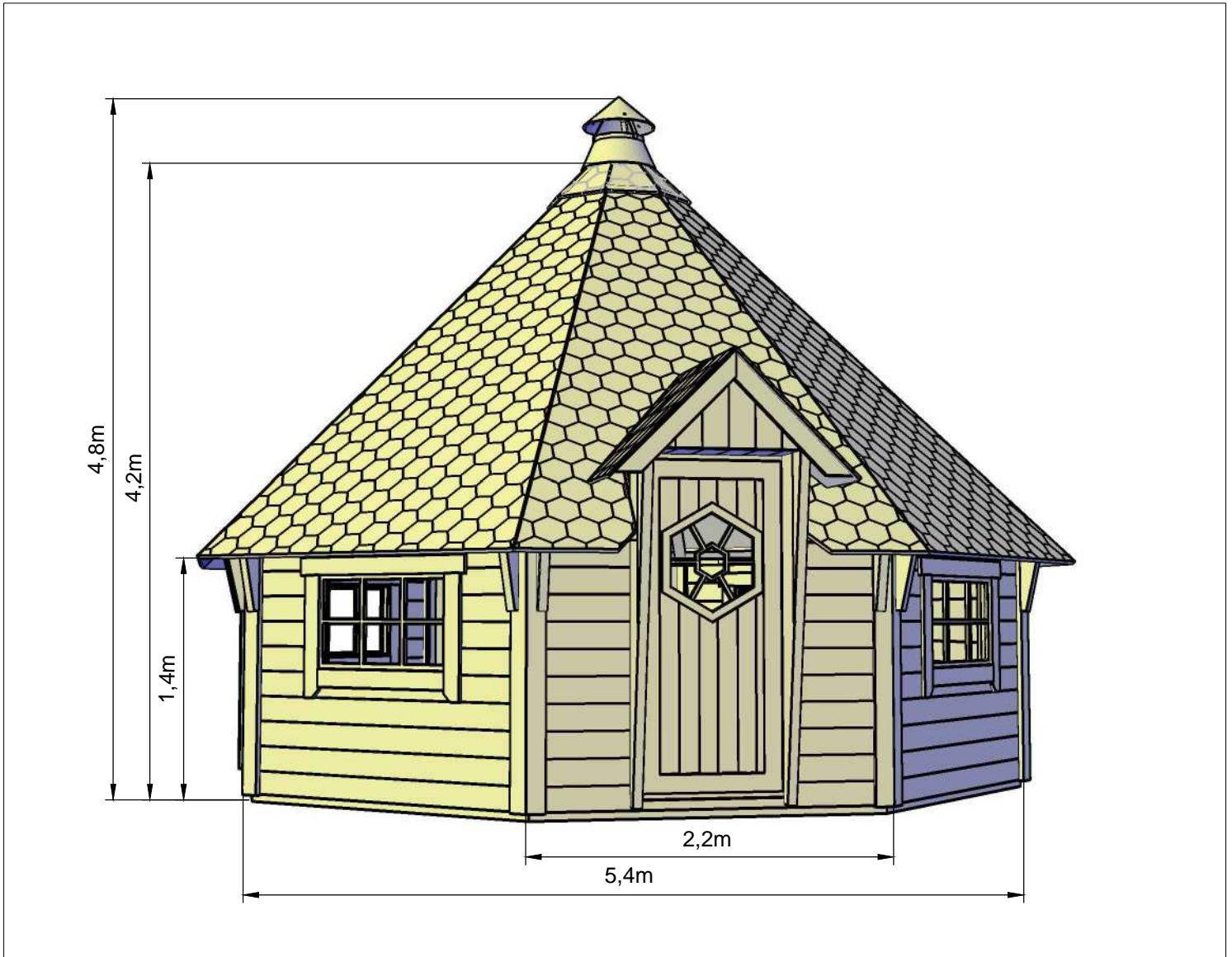

Dear customer,

We are glad that you have decided in favour of our grill house!

Please read the assembly manual carefully before proceeding with the house installation! You will thus avoid problems and will not waste time.

Recommendations:

- Keep the house package until its complete assembly in a dry place, but not in direct contact with the ground, protected from weather conditions (moisture, the sun, etc.). Do not keep the house package in a heated room!
- When selecting the garden house location, make sure that the house will not be subjected to extreme weather conditions (areas of strong snowfall or winds); otherwise you should attach the house (for instance, with anchors) to the subsoil.

Warranty











Your house is made from high quality wood and delivered in the natural (unprocessed) form. If, despite our thorough inspection, you should have complaints, please contact to the product seller.

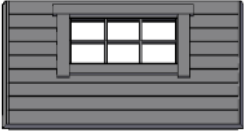
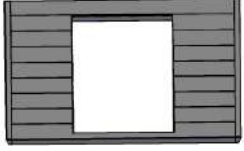





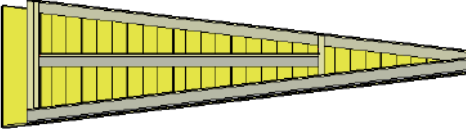
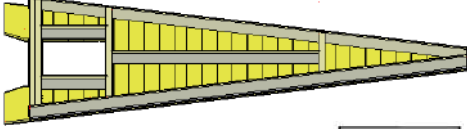
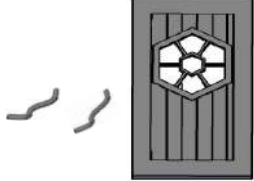





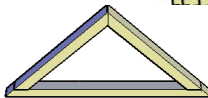





ATTENTION: Please be sure to keep the documentation accompanying the house package!
We can only review complaints if you submit the number of the house to the seller!







The warranty does not cover:

- Peculiarities of wood as a natural material
- Wooden details already painted (processed with a wood preservative)
- Wooden details containing whole branches that do not endanger the stability of the house
- Colour tone variations caused by wood structure differences that do not influence wood lifetime
- Wooden details containing (caused by drying) small cracks/gaps that do not pass through and do not influence the structure of the house
- Twisted wooden details if they can nevertheless be installed
- Roof and floor boards that may have on their concealed surfaces some non-planed areas, colour differences and waning
- Complaints resulting from an incompetent manner of the installation of the house or the house subsiding due to an incompetently made foundation
- Complaints caused by introducing self-initiative changes to the house, such as the deformation of wooden details and doors/windows due to an incompetent manner of wood processing, etc.

The complaints covered by the warranty are satisfied to the extent of replacing the deficient/faulty material. All other demands will be excluded!

Nr.	Dimensions	Detail	Pcs	✓
1	Wall bottom 2205mm		8	<input type="checkbox"/>
2	The Wall 1335x2225mm		3	<input type="checkbox"/>
3	The wall, window 1335x2225mm		4	<input type="checkbox"/>
4	The wall, door 1335x2225mm		1	<input type="checkbox"/>
5	Outside corner slat 1340mm		8	<input type="checkbox"/>
6	Roof support 338mm		16	<input type="checkbox"/>
7	Roof support belt 2347mm		7	<input type="checkbox"/>
8	Roof support belt, left-right 625mm		2	<input type="checkbox"/>
9	Shelf 350mm		8	<input type="checkbox"/>
10	Roof detail		7	<input type="checkbox"/>
11	Roof detail, door		1	<input type="checkbox"/>
12	Door + door handle x 2 1080x1730mm		1	<input type="checkbox"/>
13	Door side slat (outside) 1760mm		2	<input type="checkbox"/>

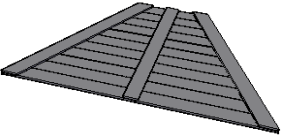
Nr.	Dimensions	Detail	Pcs	✓
14	Small roof bottom		1	<input type="checkbox"/>
15	Covered triangle, small roof		1	<input type="checkbox"/>
16	Uncovered triangle, small roof		1	<input type="checkbox"/>
17	Wind veneer, small roof		2	<input type="checkbox"/>
18	Small roof detail; left, right		2	<input type="checkbox"/>
20	Small roof side detail		2	<input type="checkbox"/>
21	Lower edge slat, small roof		2	<input type="checkbox"/>
22	Front covering slat, small roof		2	<input type="checkbox"/>
23	Console		14	<input type="checkbox"/>
24	Sitting board 1972mm		7	<input type="checkbox"/>
25	Sitting board 2144mm		7	<input type="checkbox"/>
26	Sitting board 2198mm		3	<input type="checkbox"/>
27	Widening support leg		6	<input type="checkbox"/>
28	Roof inner slat 70x3900mm (oversize x8)		8	<input type="checkbox"/>
30	Filling board for the small roof Left-right side		2	<input type="checkbox"/>
31	Door slat (inside) 70x1500mm (side)		2	<input type="checkbox"/>
32	70x300mm (side)		2	<input type="checkbox"/>
33	70x1400mm(up)		1	<input type="checkbox"/>
34	70x1100mm (up)		1	<input type="checkbox"/>

Nr.	Dimensions	Detail	Pcs	✓
35	Connection cover strip 250x1005mm		60	<input type="checkbox"/>
36	Corner connection, door side cover strip roll 0,25x1,2m		1+1	<input type="checkbox"/>
37	Covered pipe detail		1	<input type="checkbox"/>
38	Metal hut		1	<input type="checkbox"/>
40	Metal top		1	<input type="checkbox"/>
41	Floor detail		8	<input type="checkbox"/>
42	Middle floor detail		1	<input type="checkbox"/>
58	Inside corner slat 70x1335mm		8	<input type="checkbox"/>

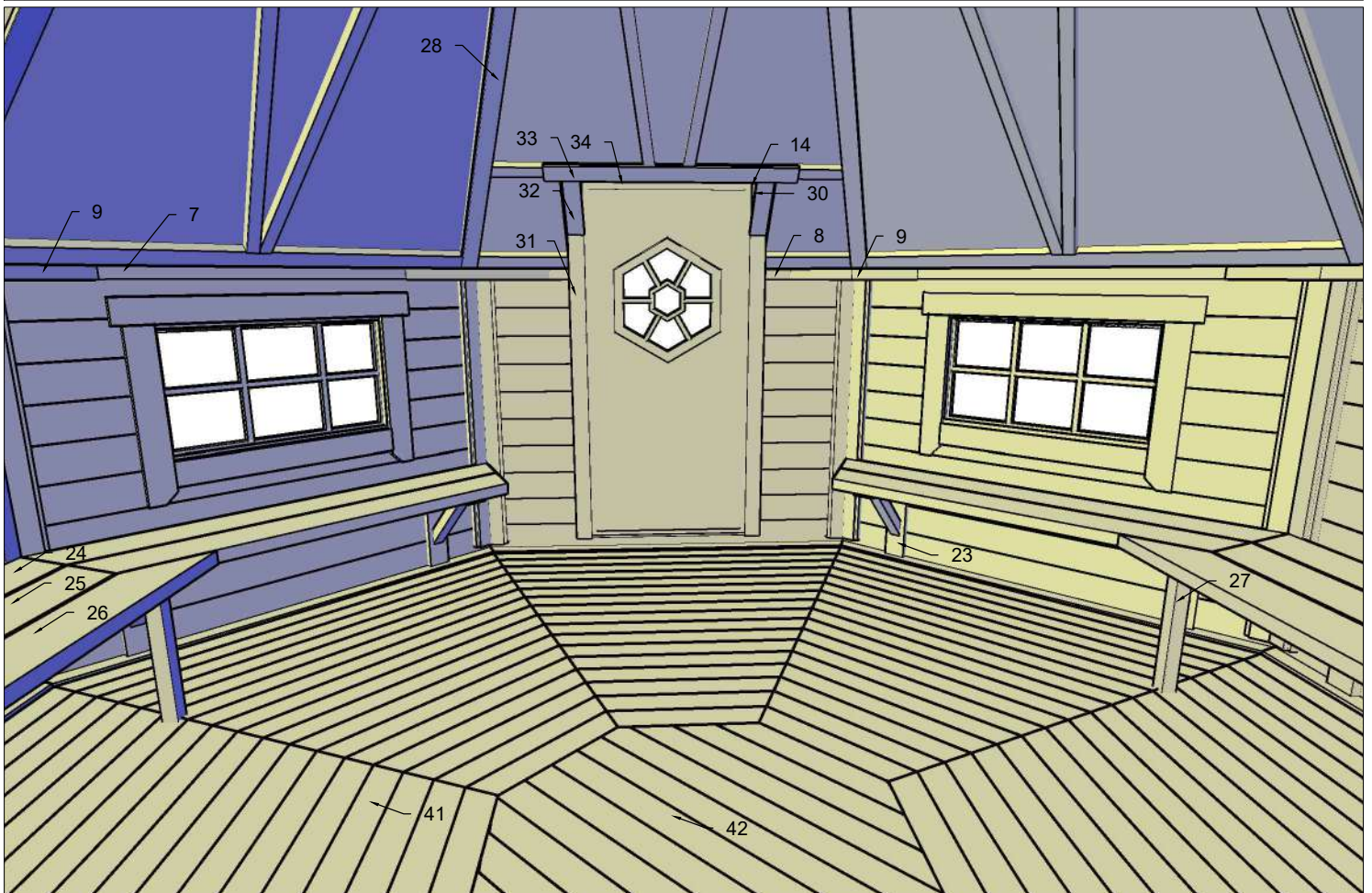
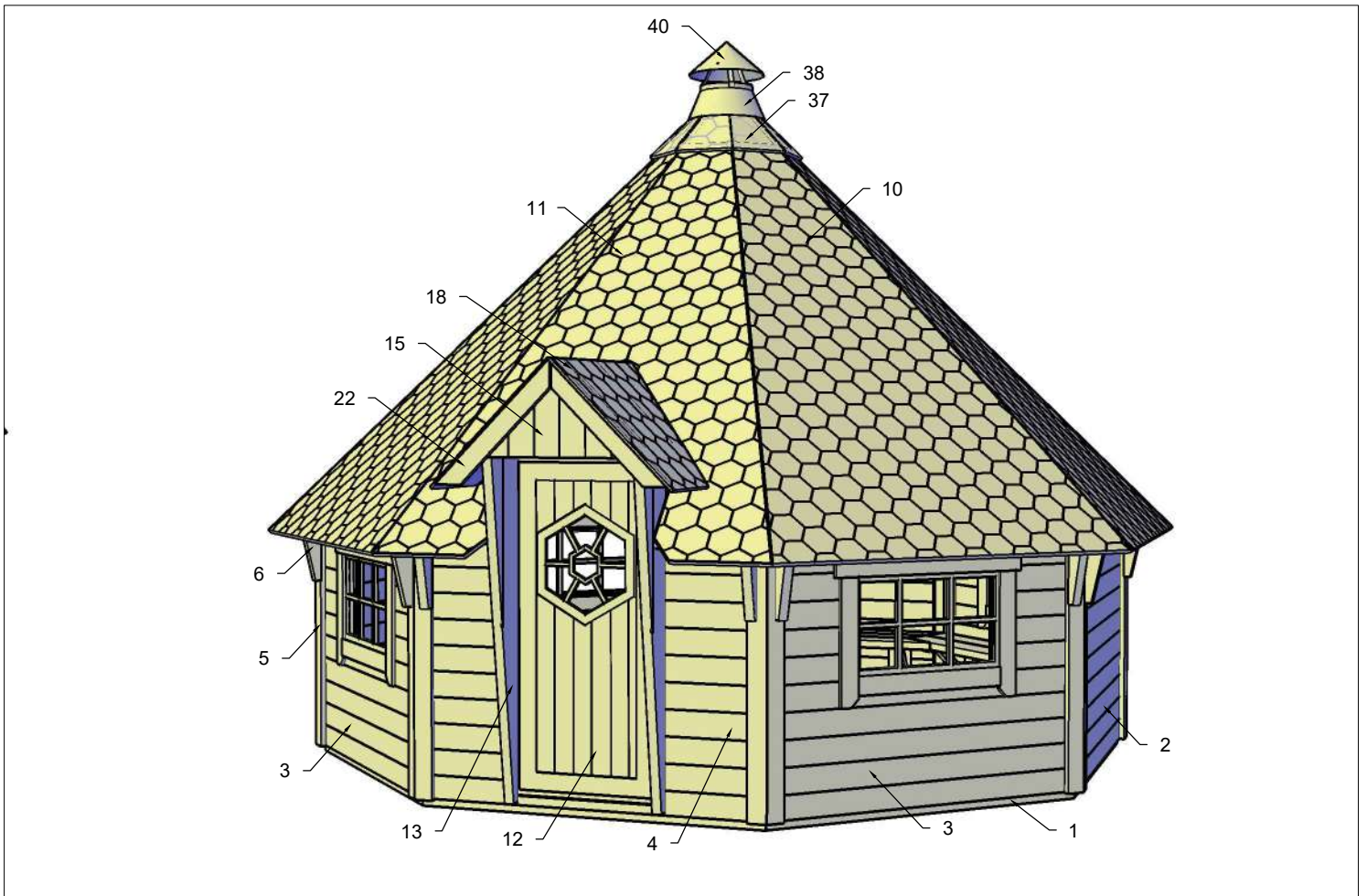

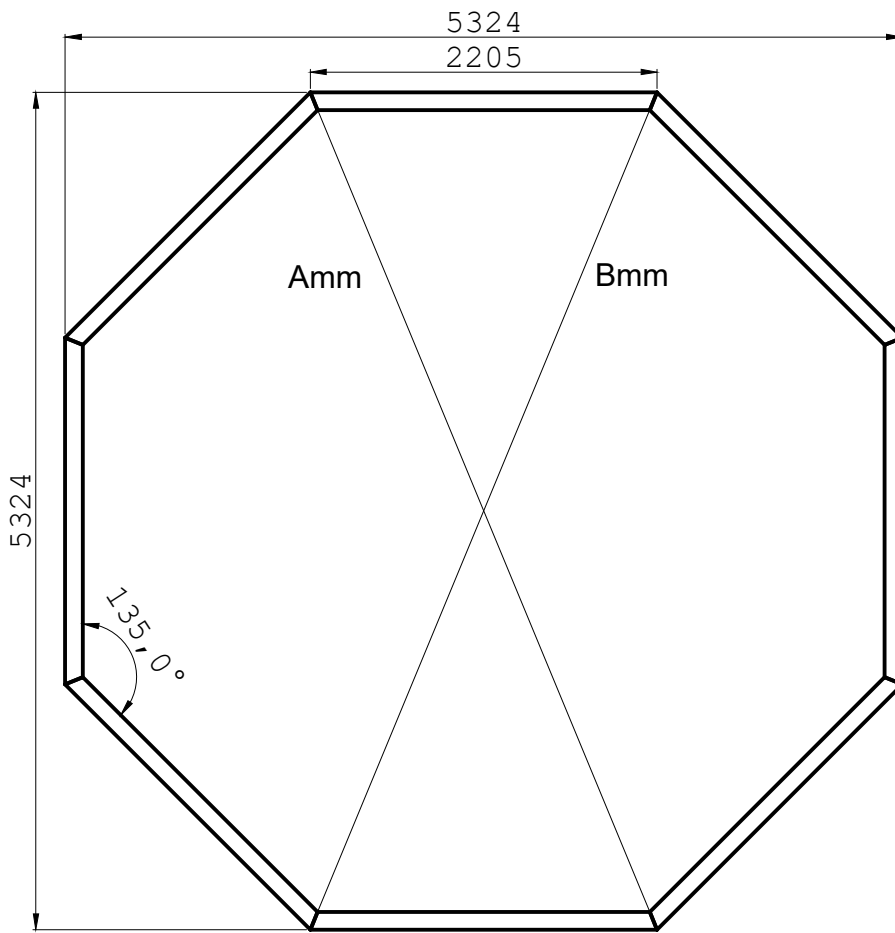

A mm = B mm

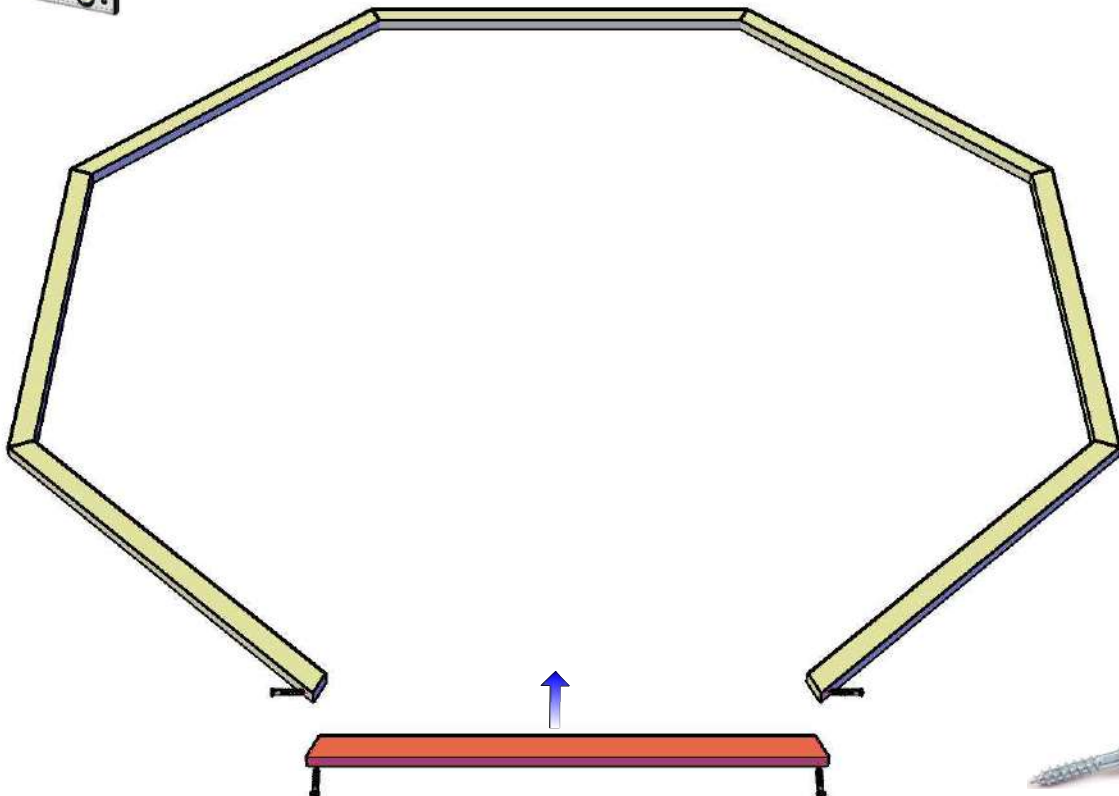

5 x 80 mm

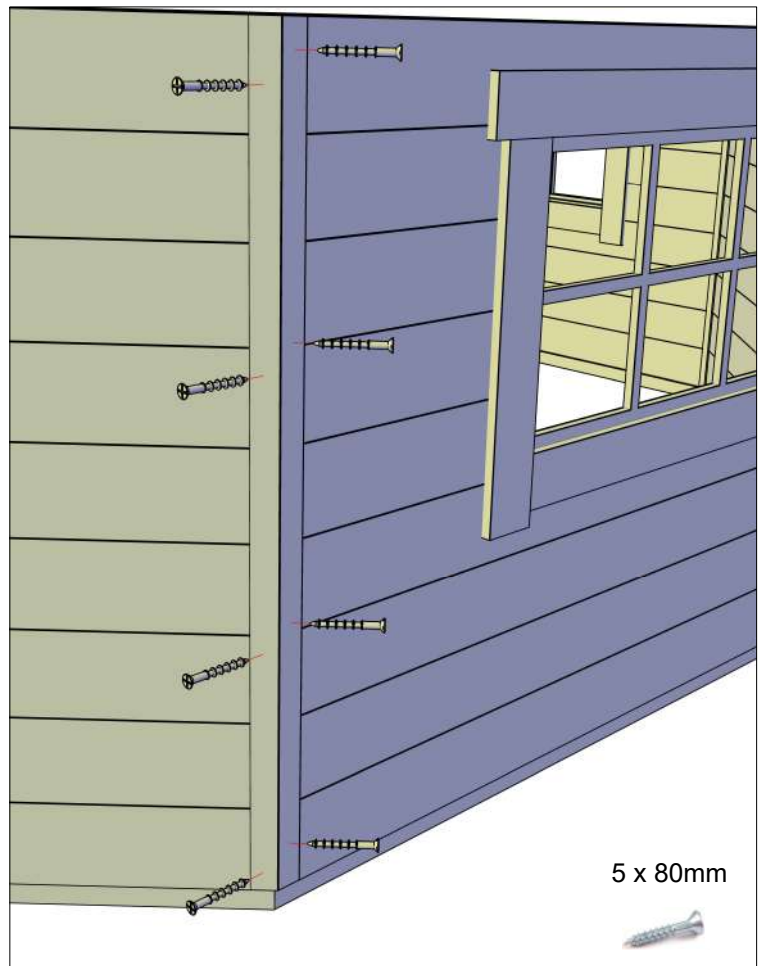
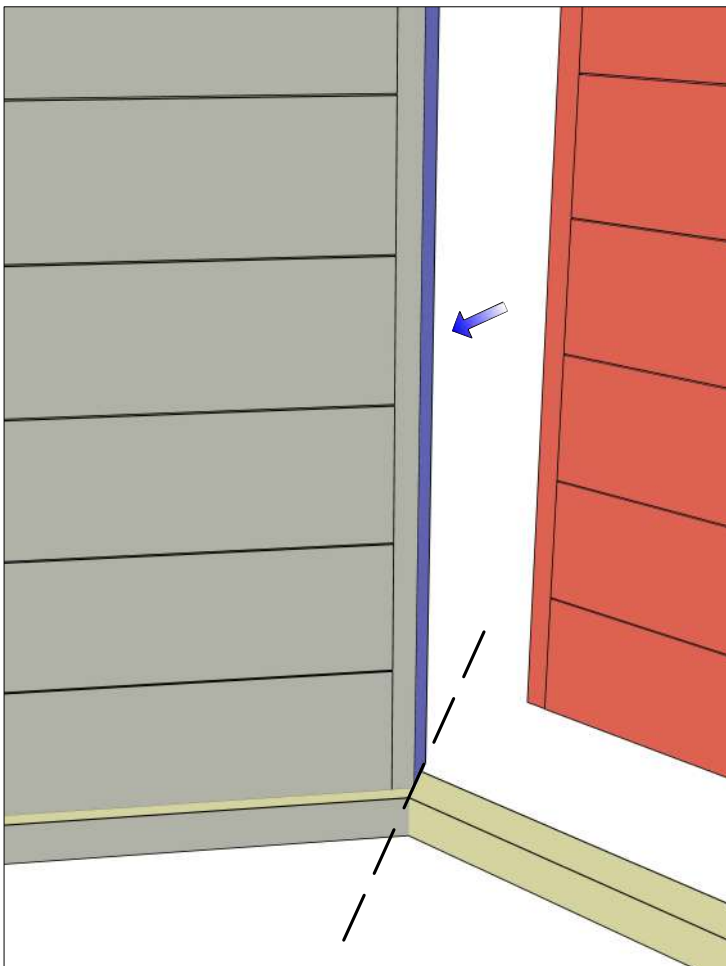
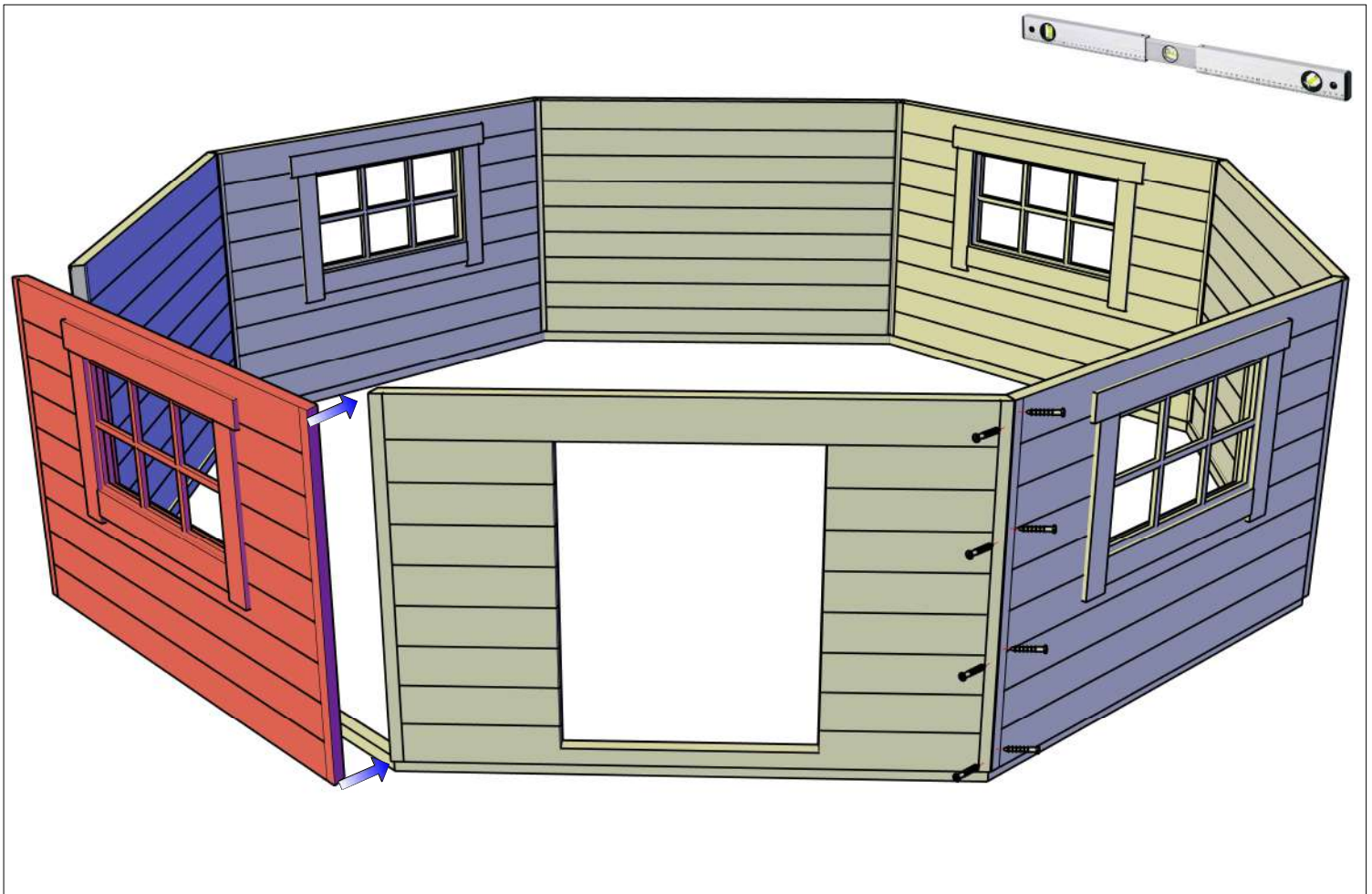

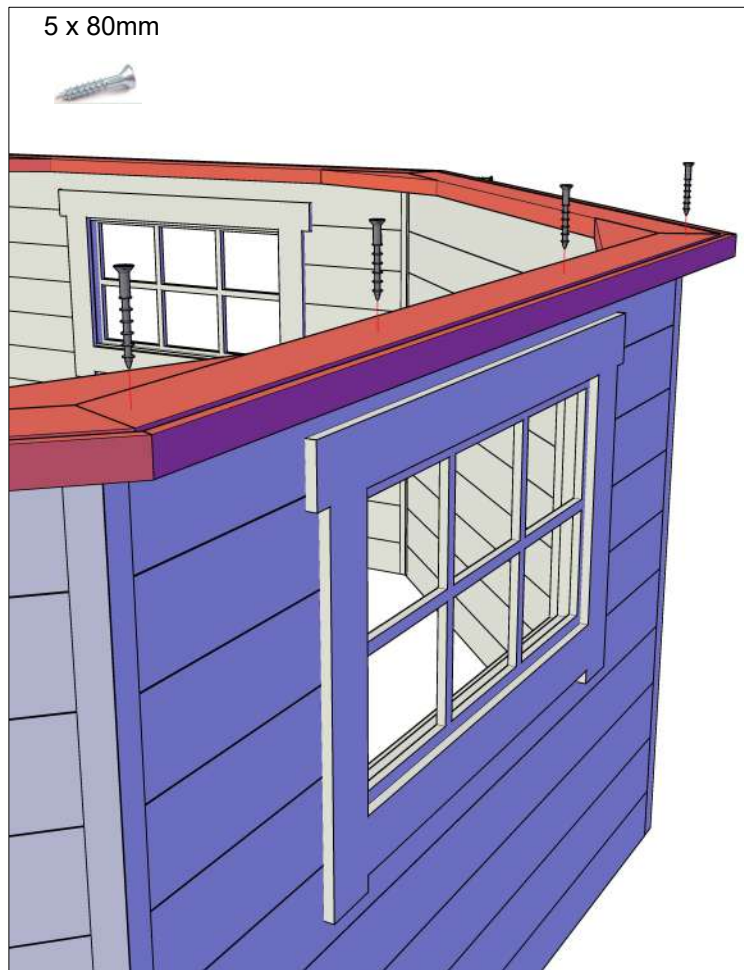
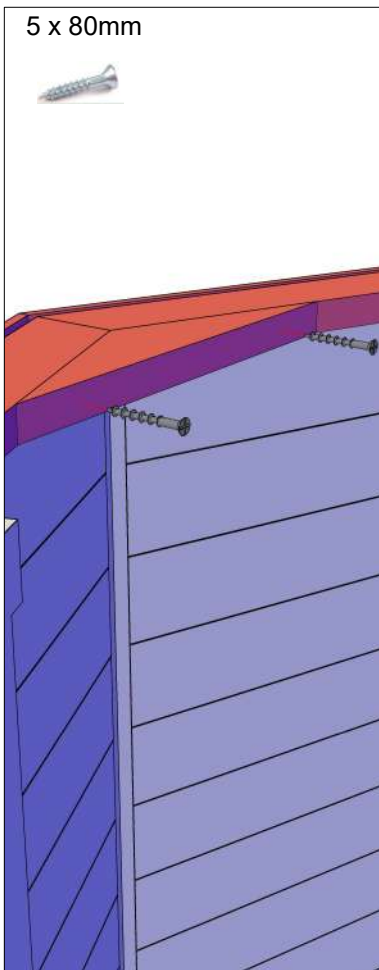
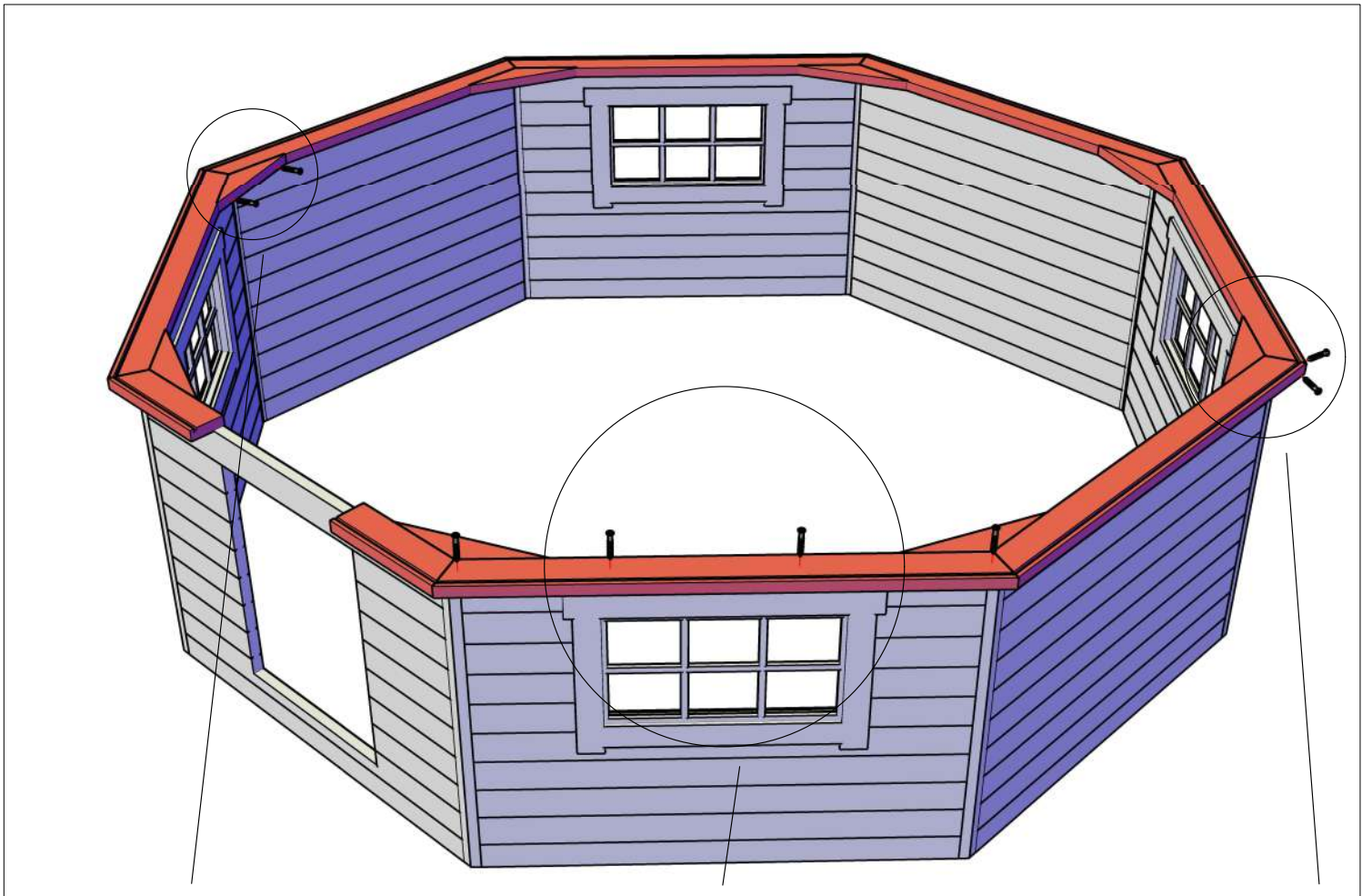

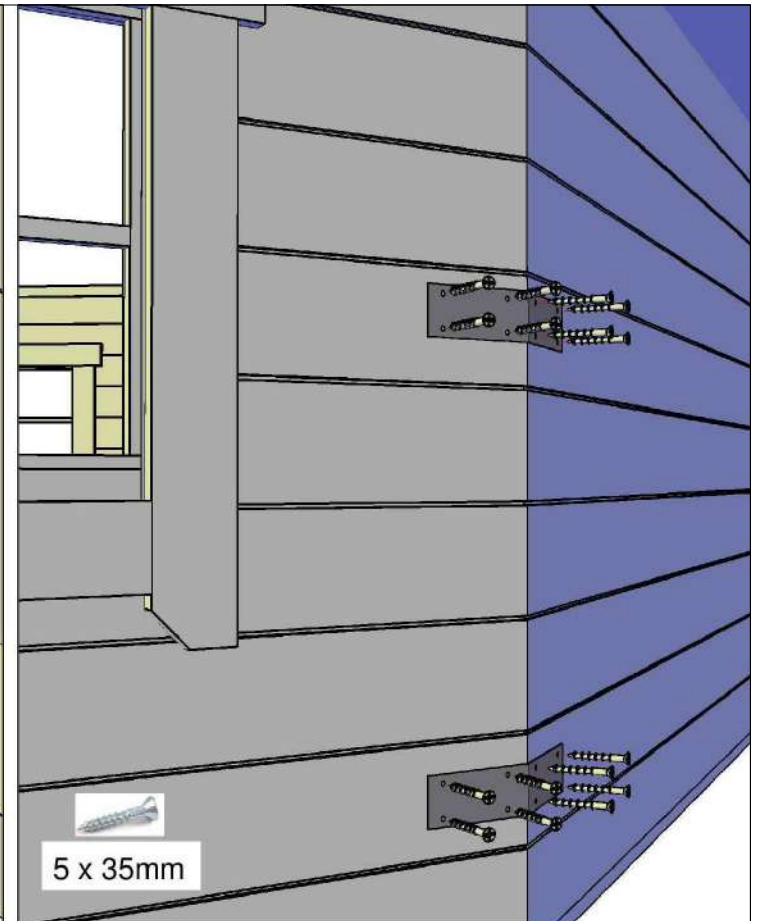
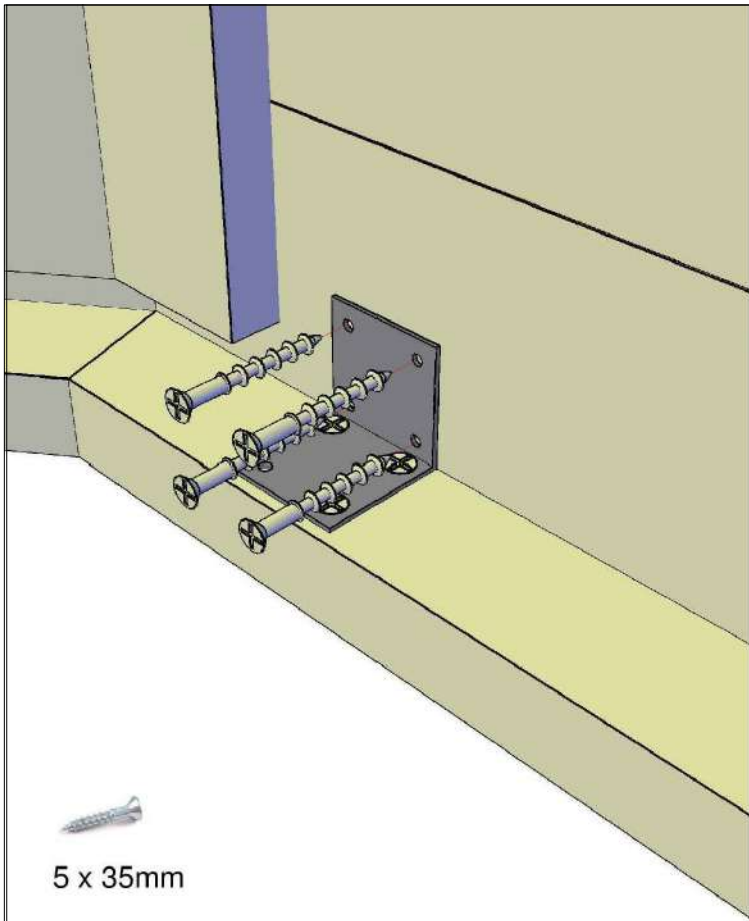
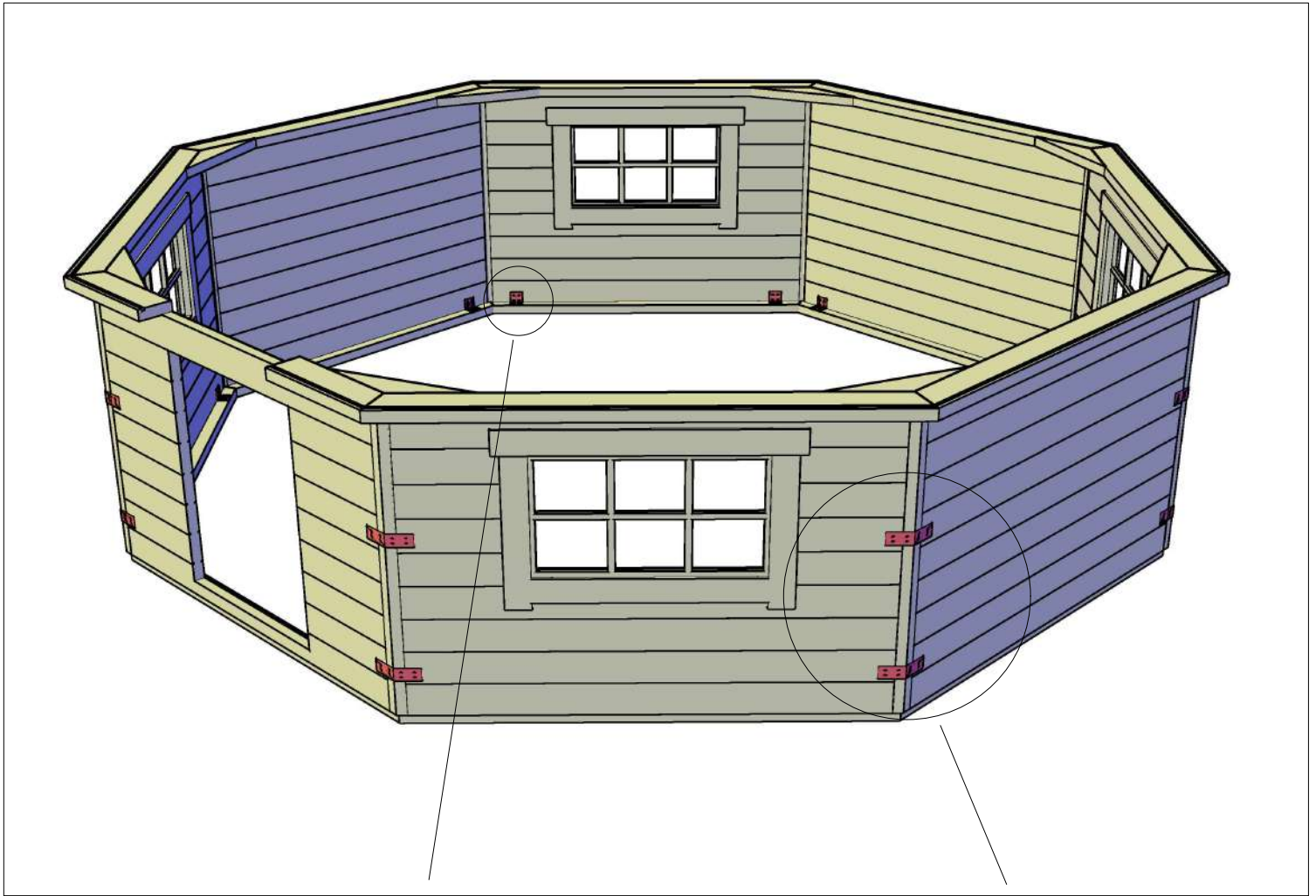

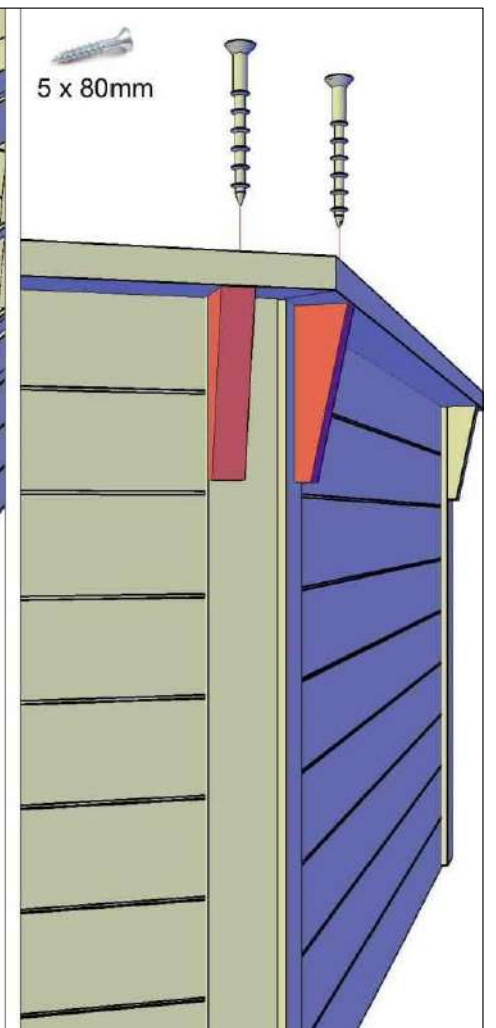
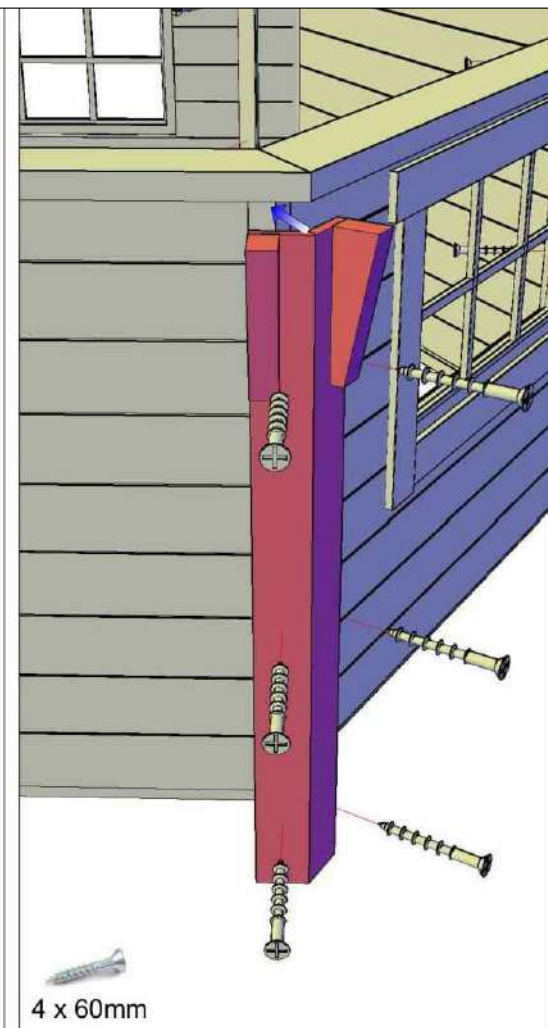
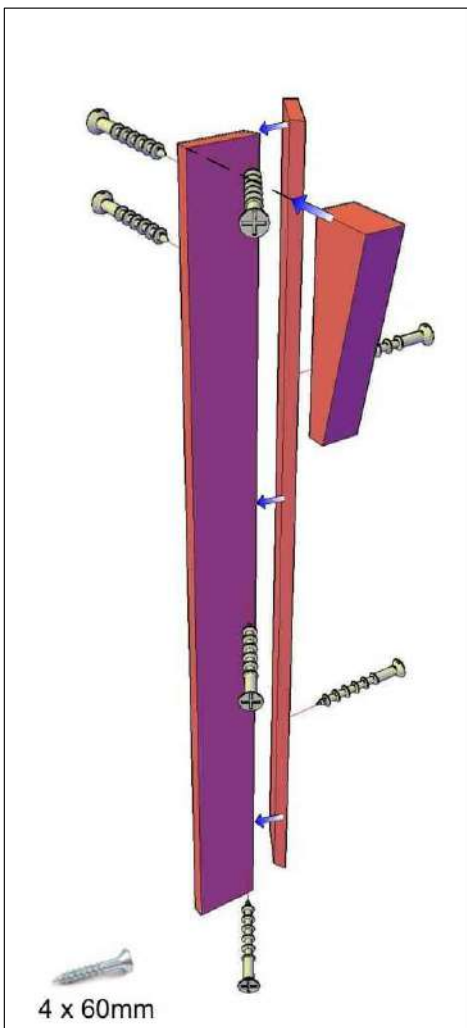
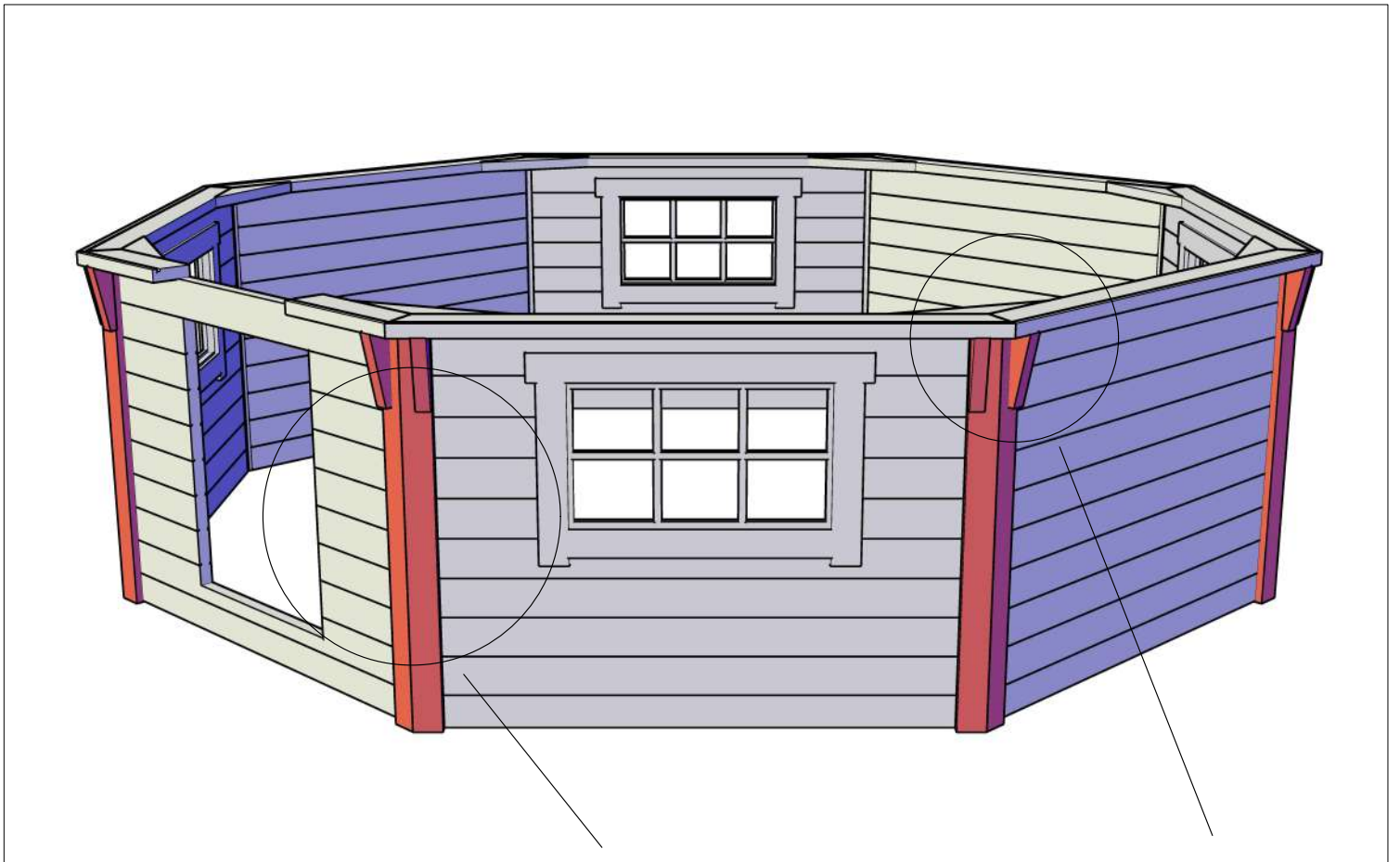

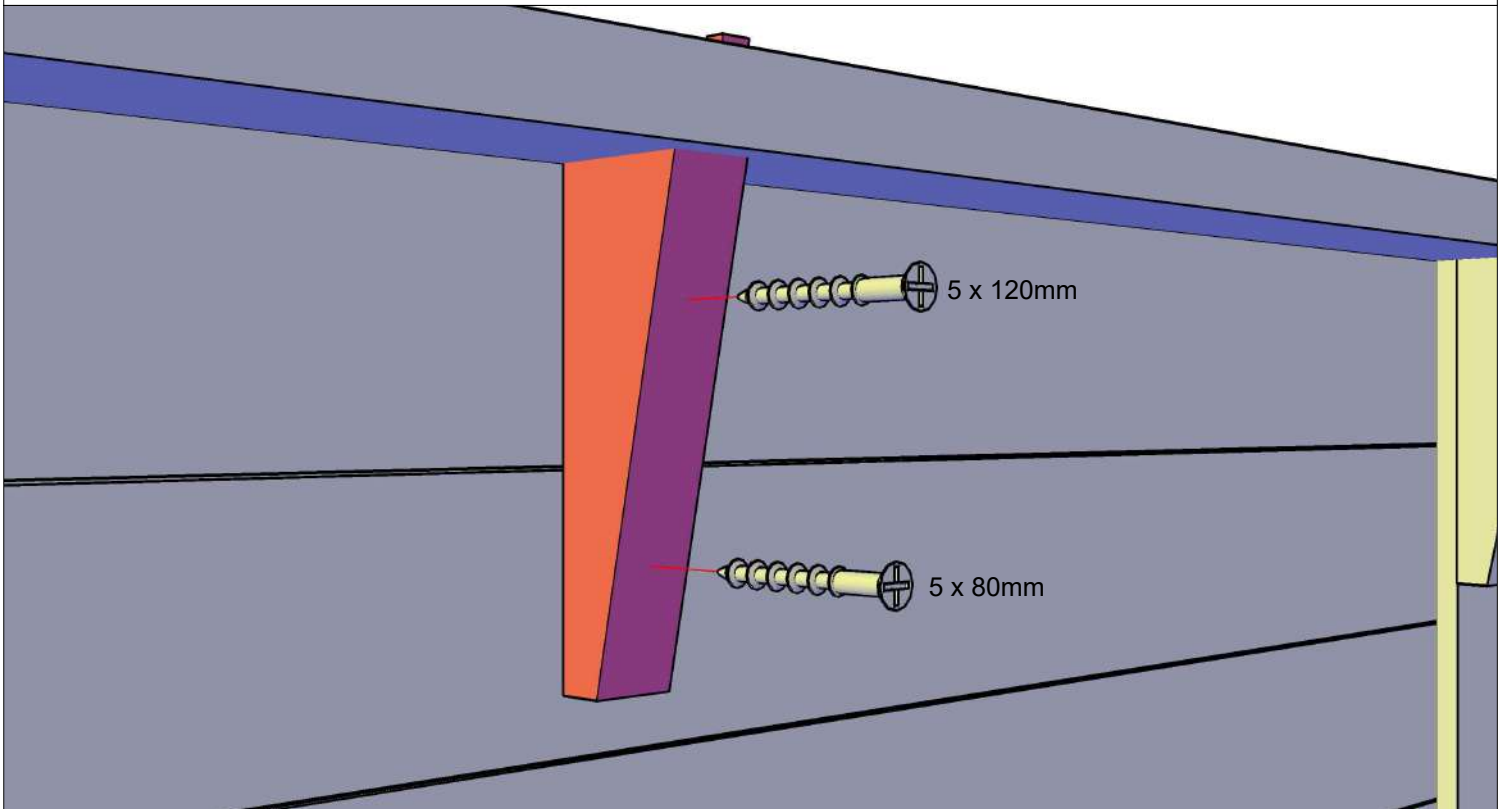
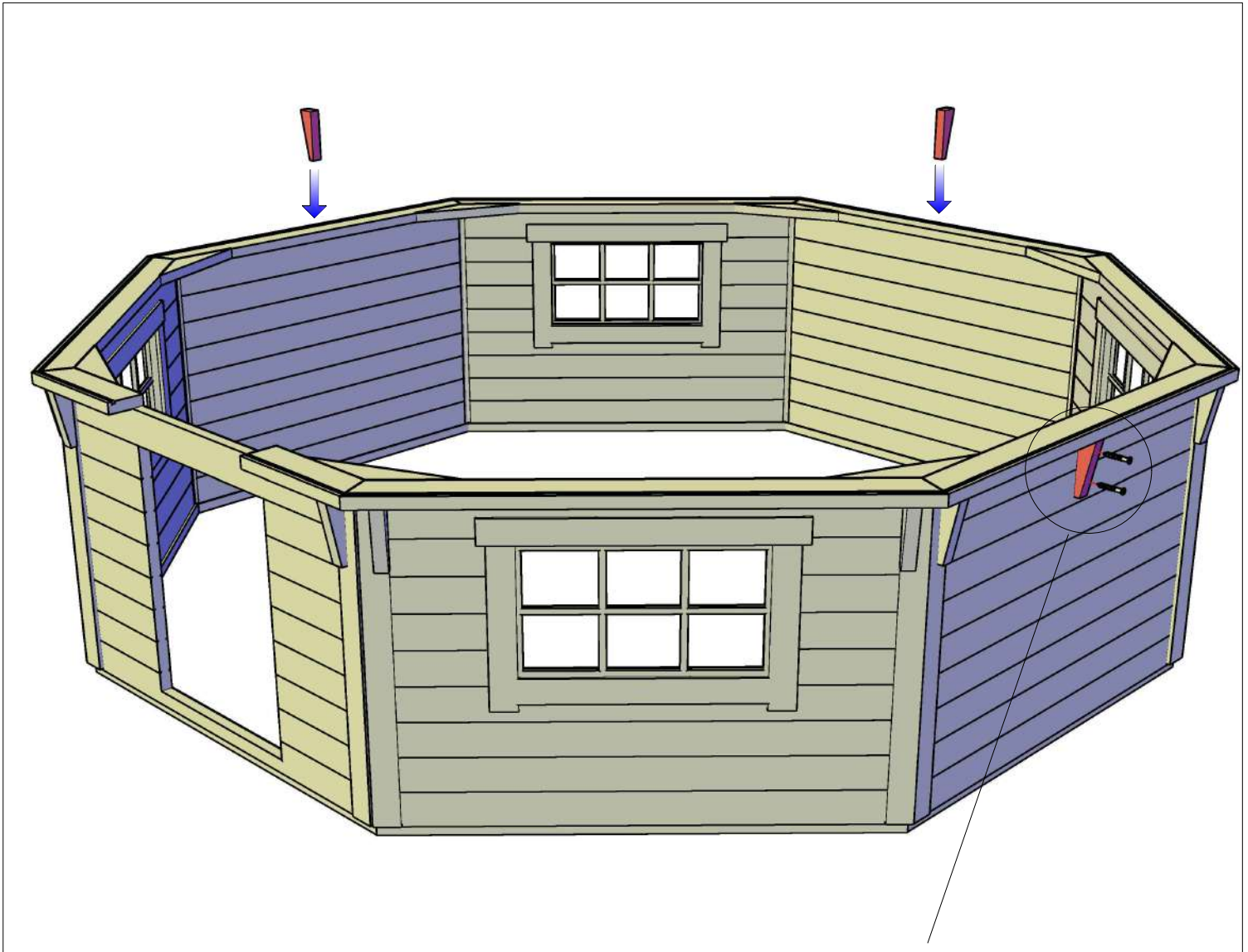

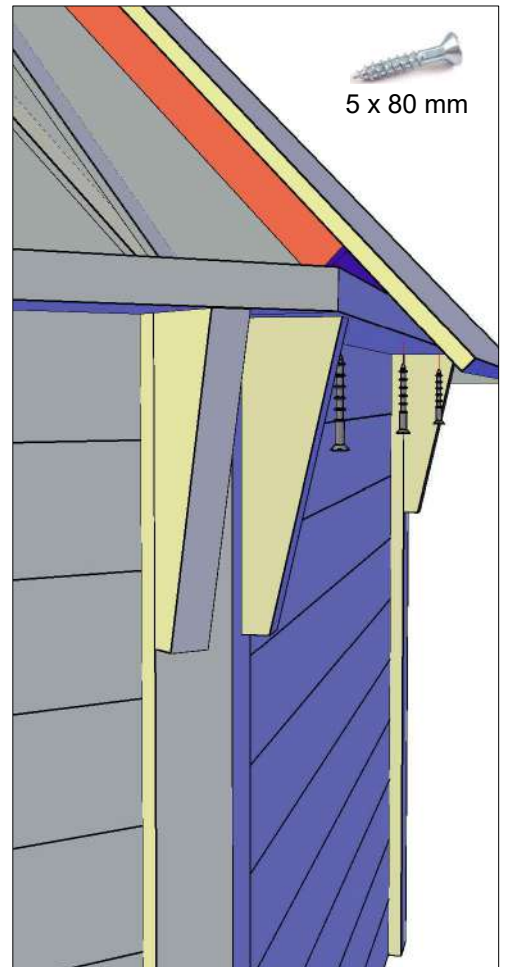
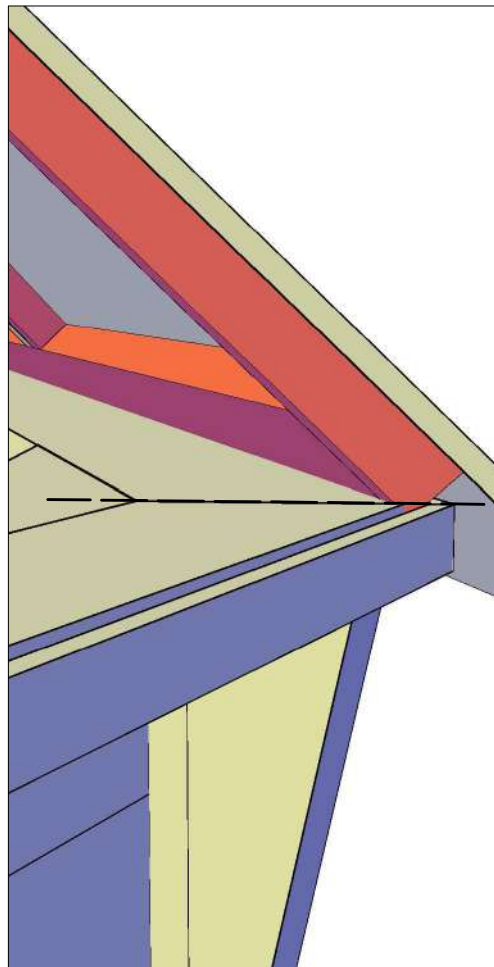
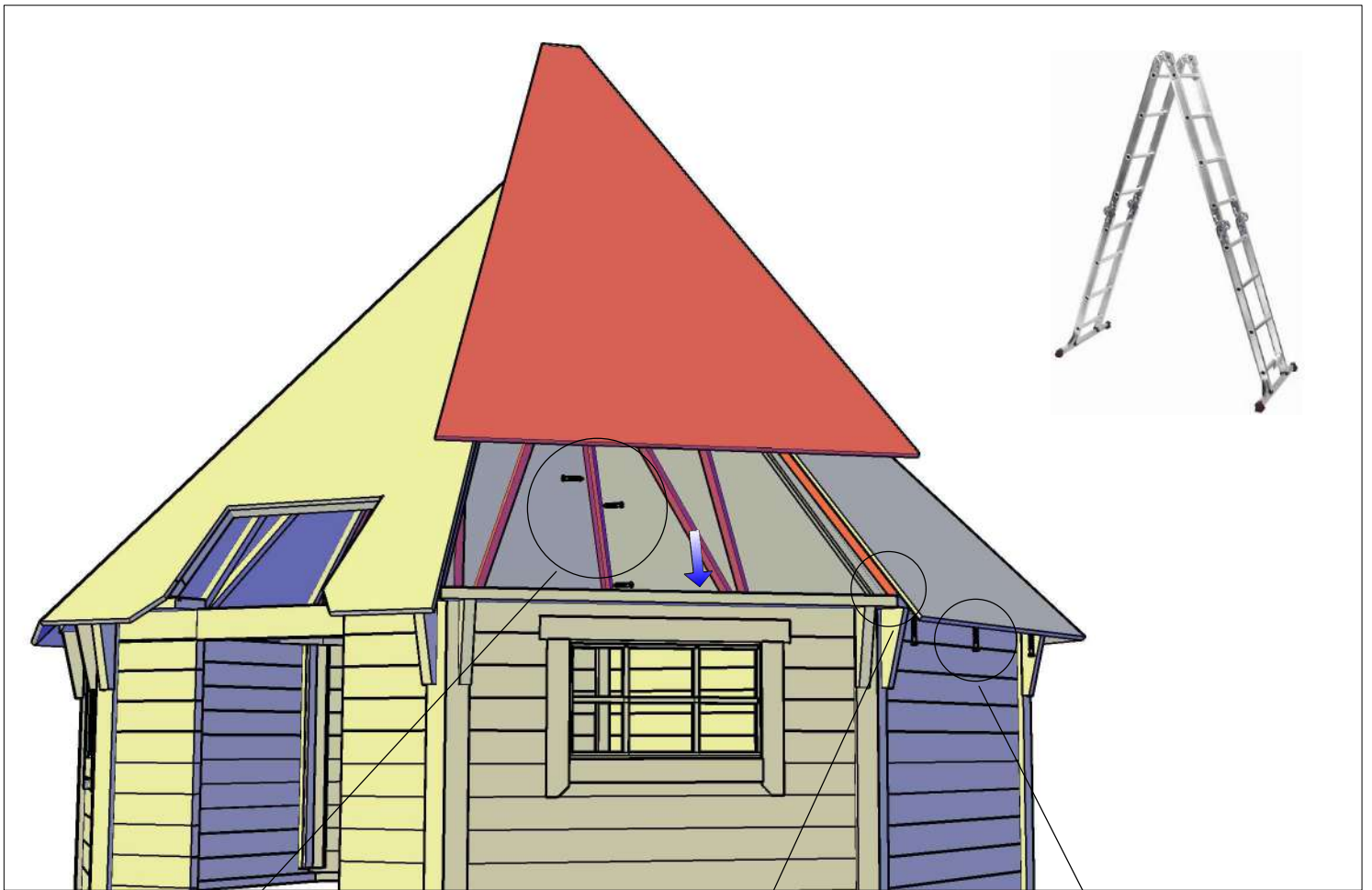

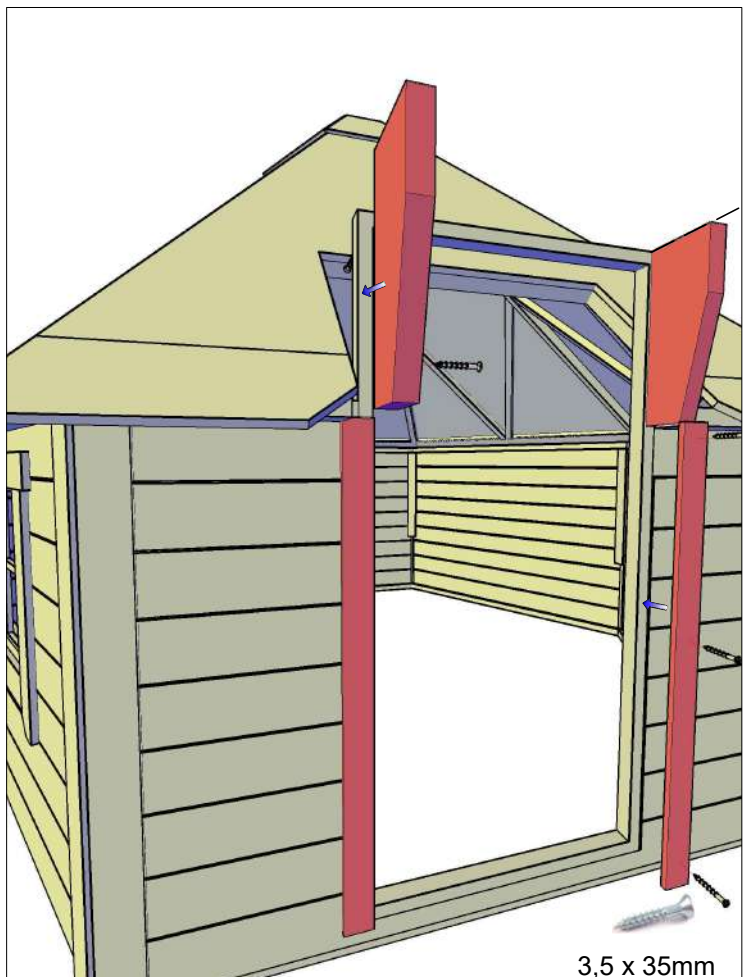
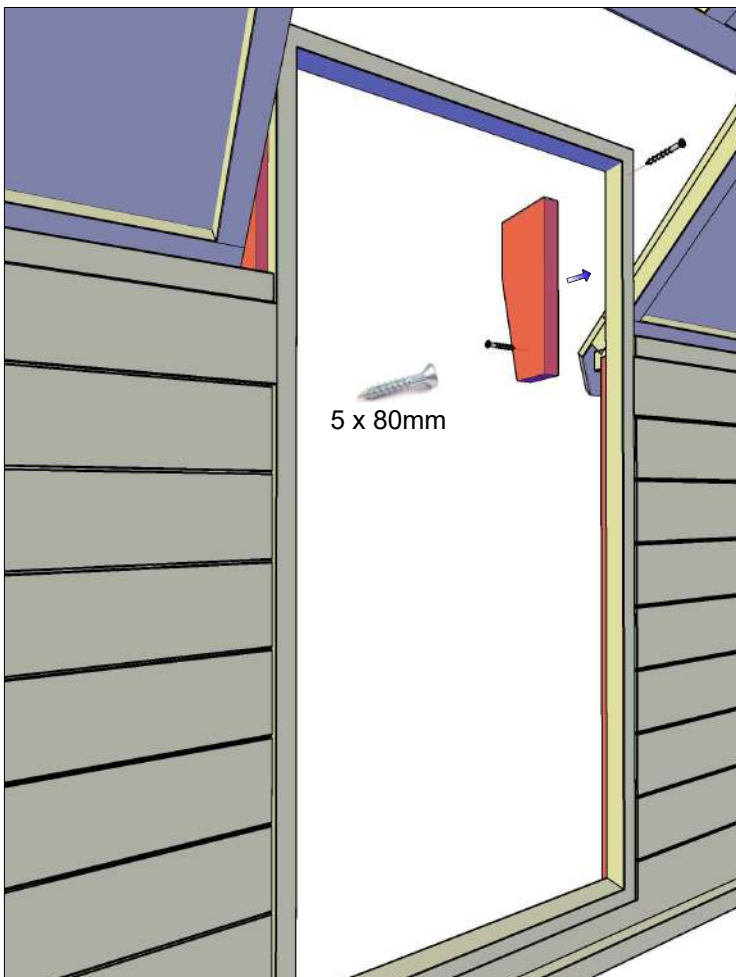
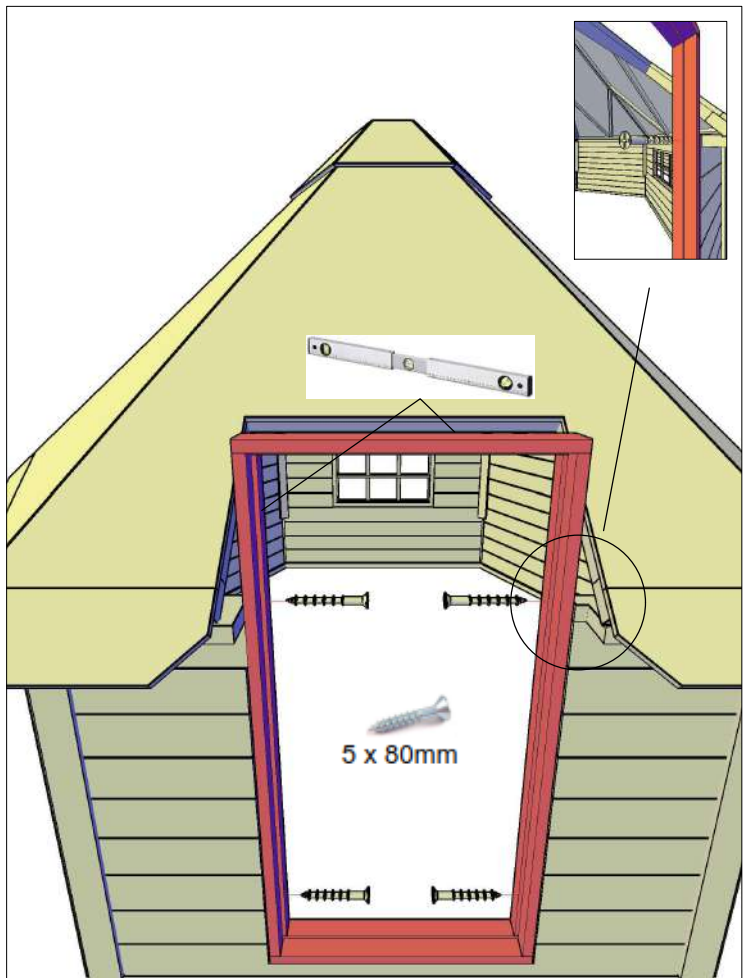
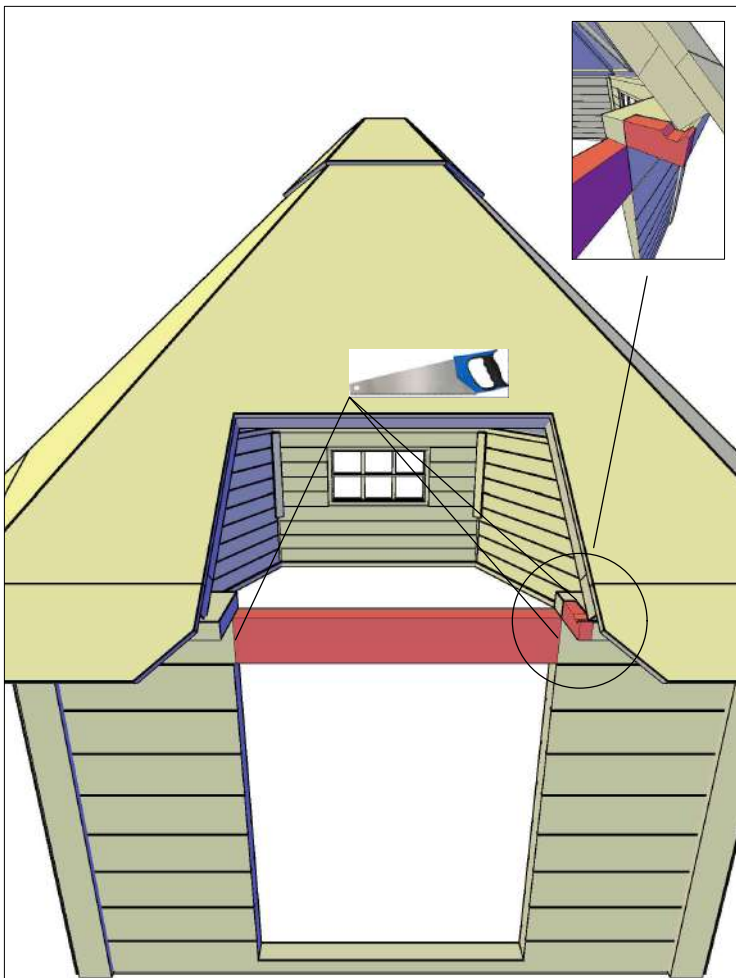

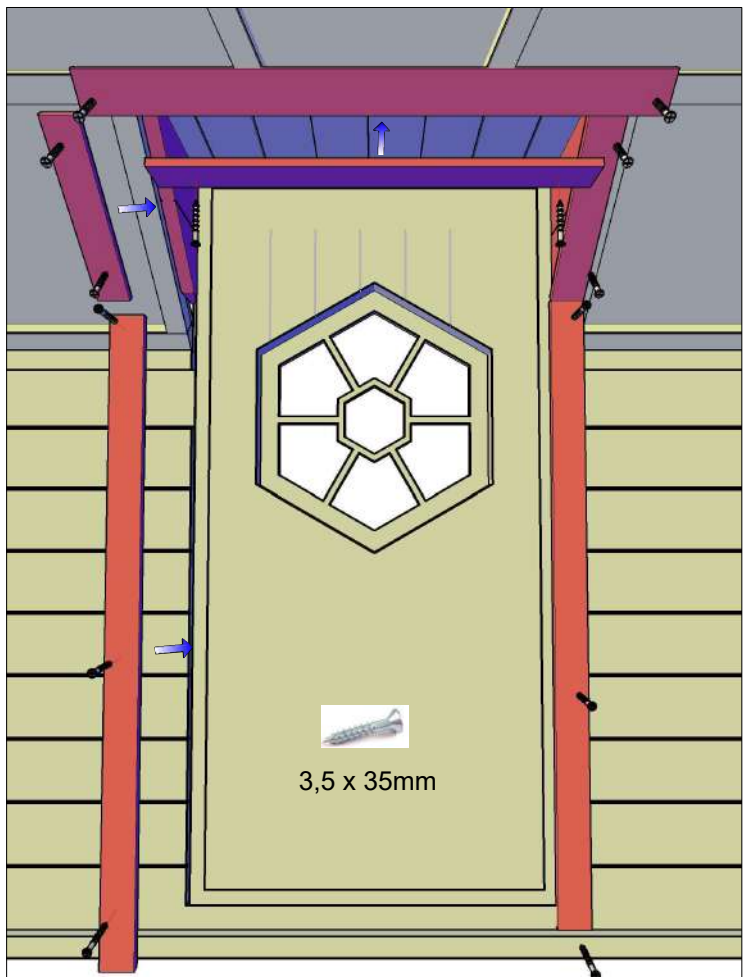
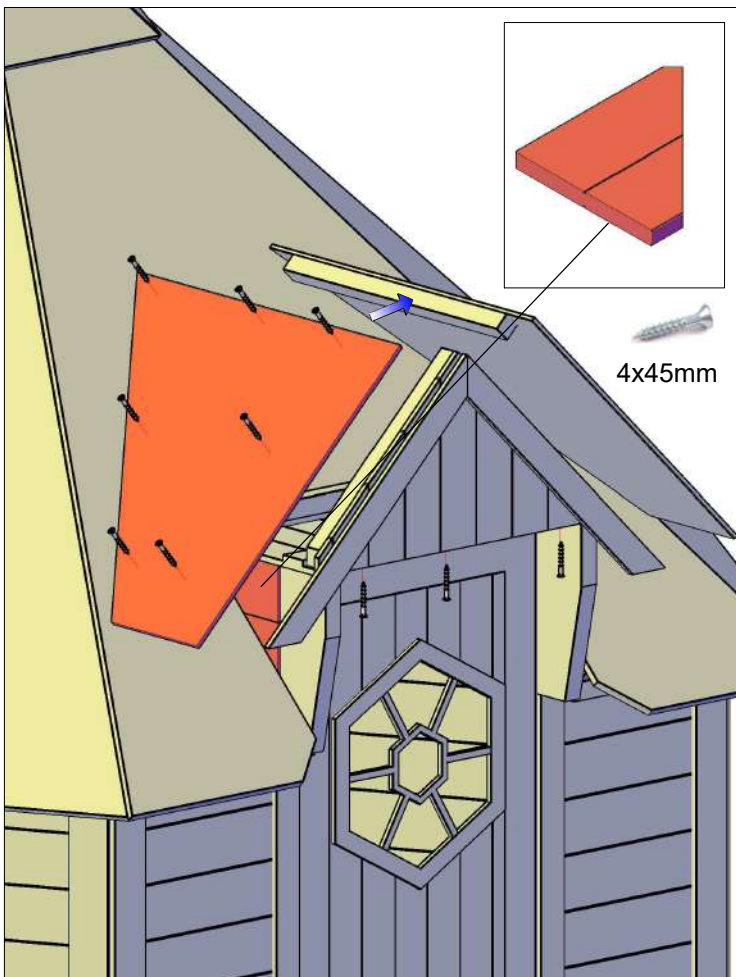
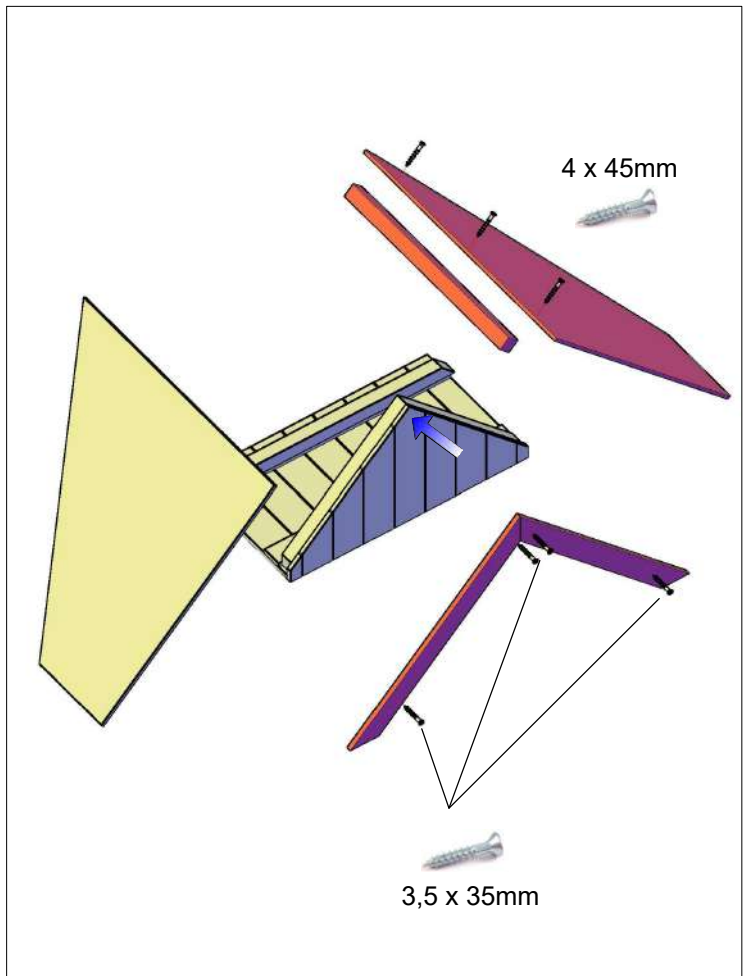
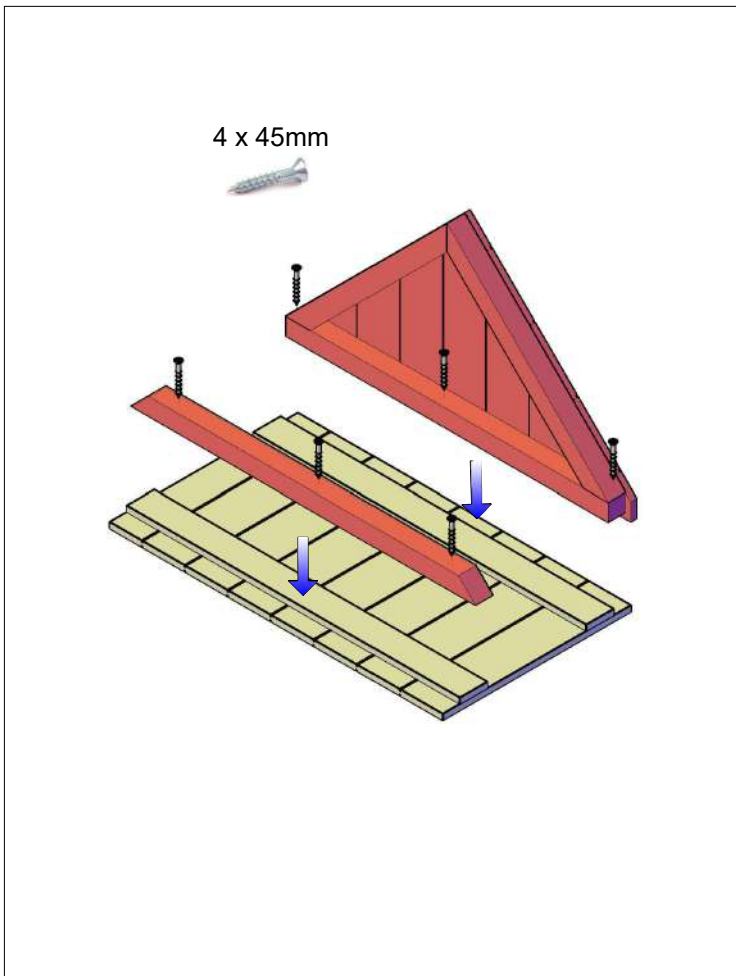

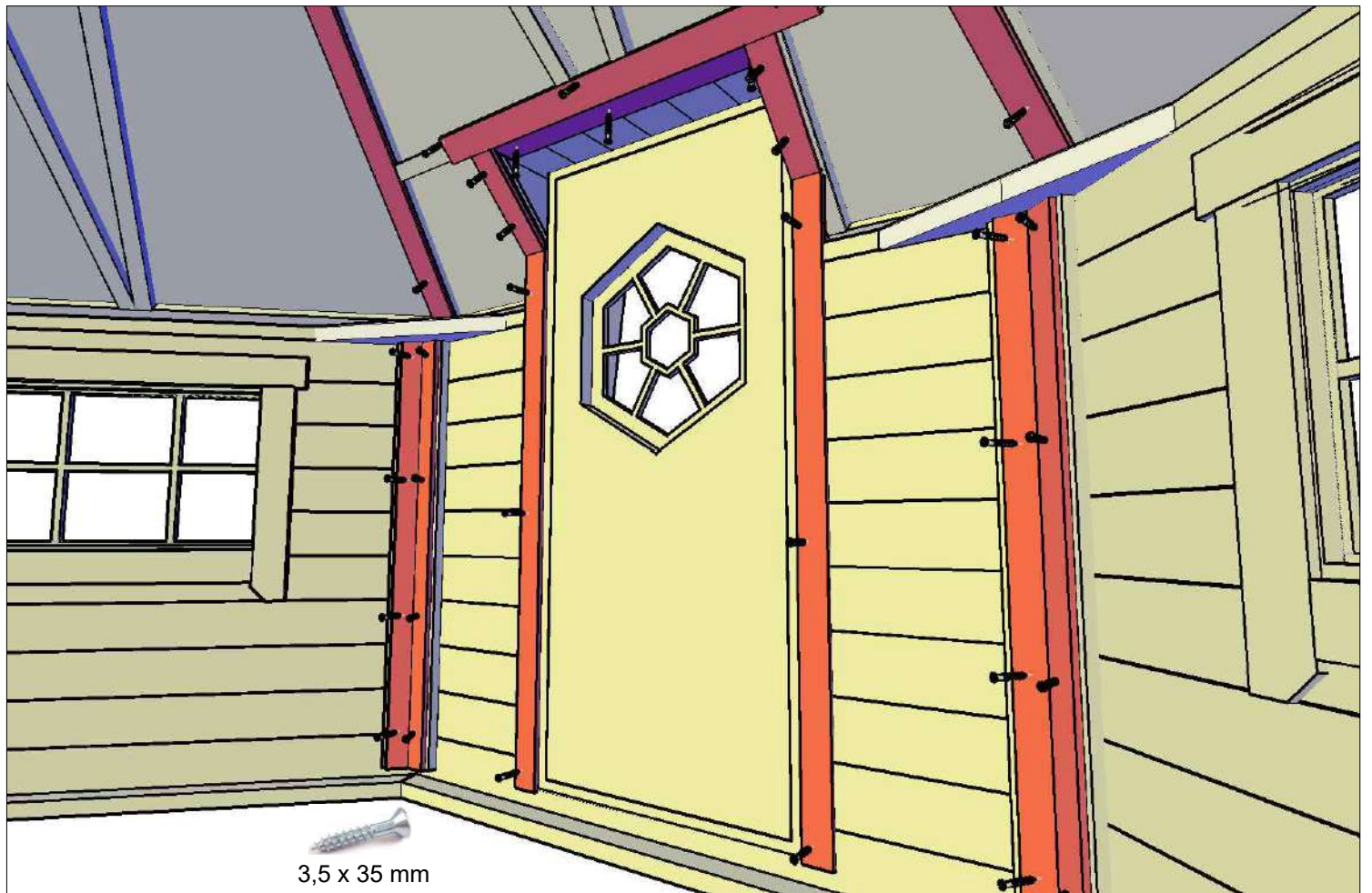

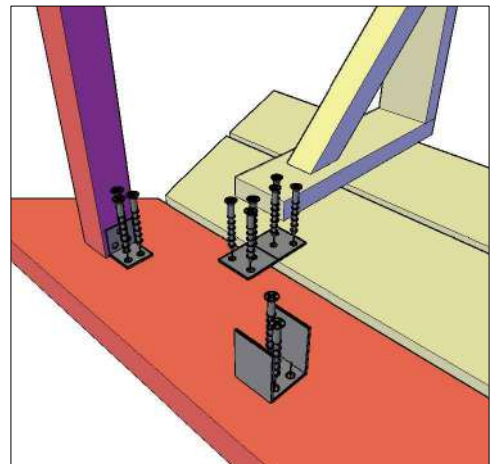
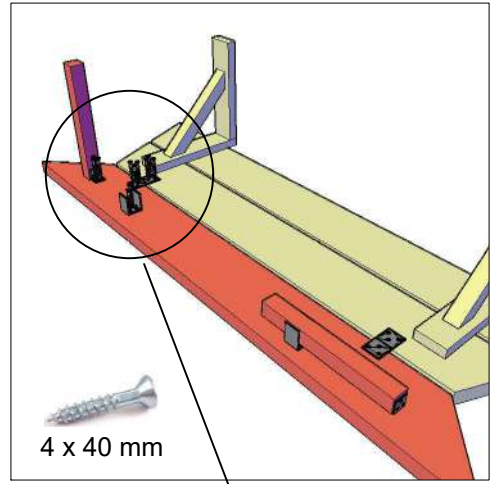
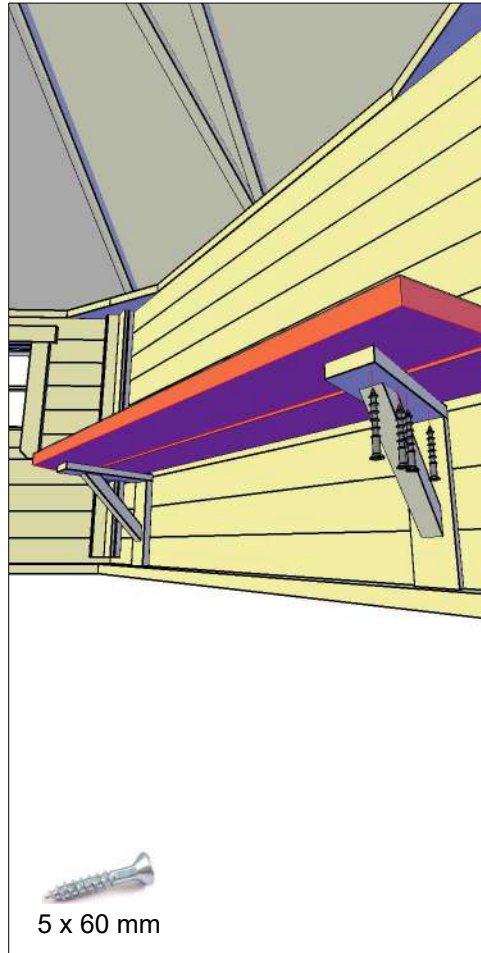
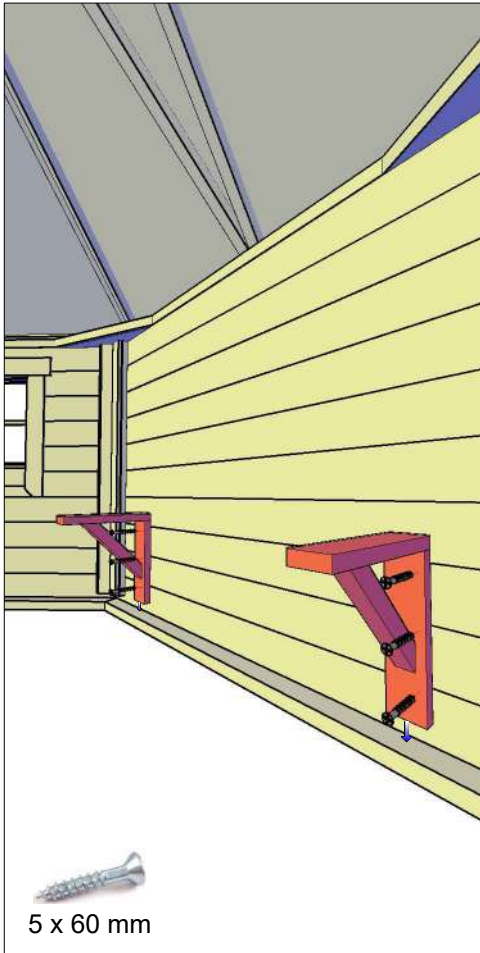
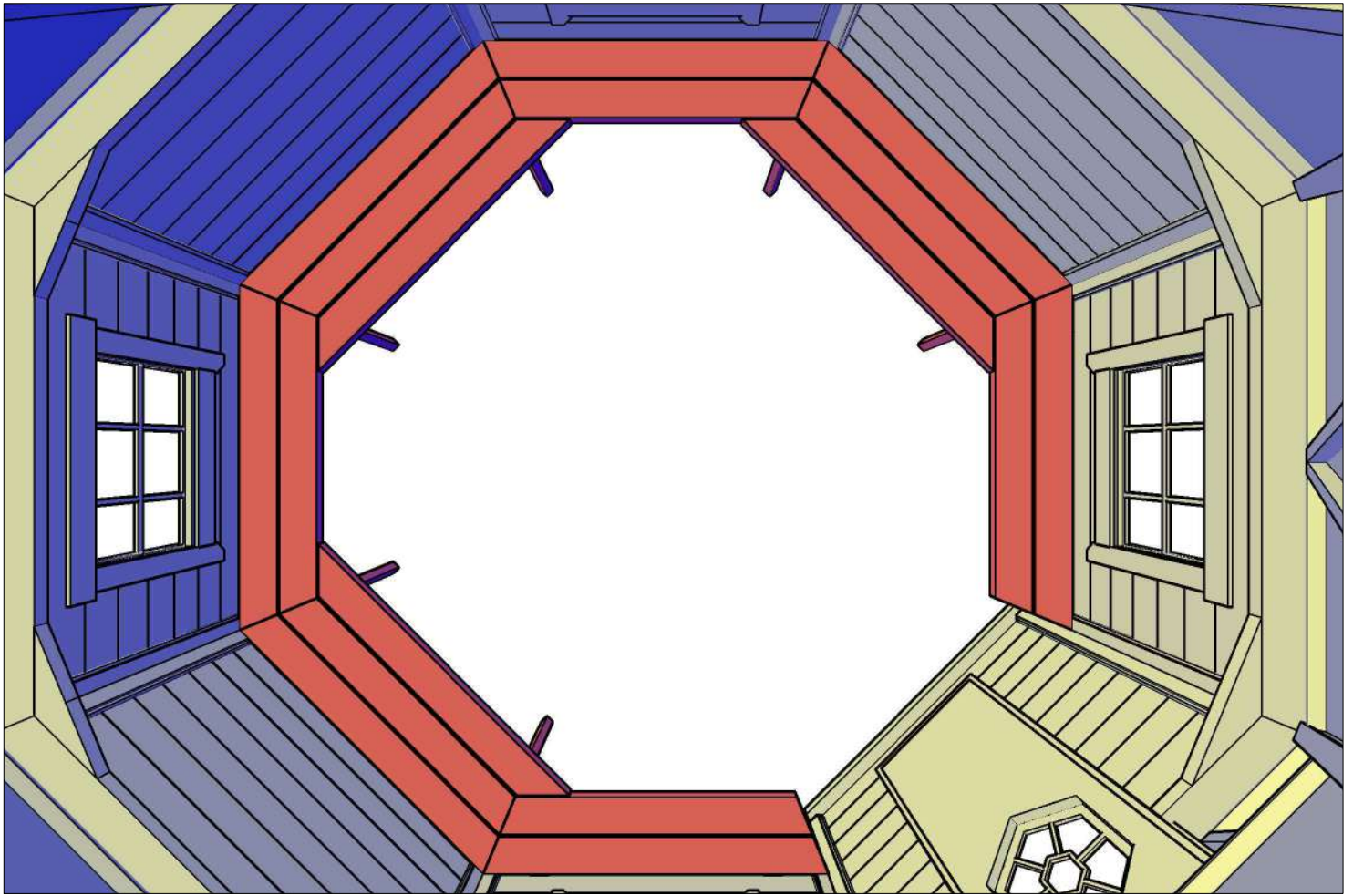

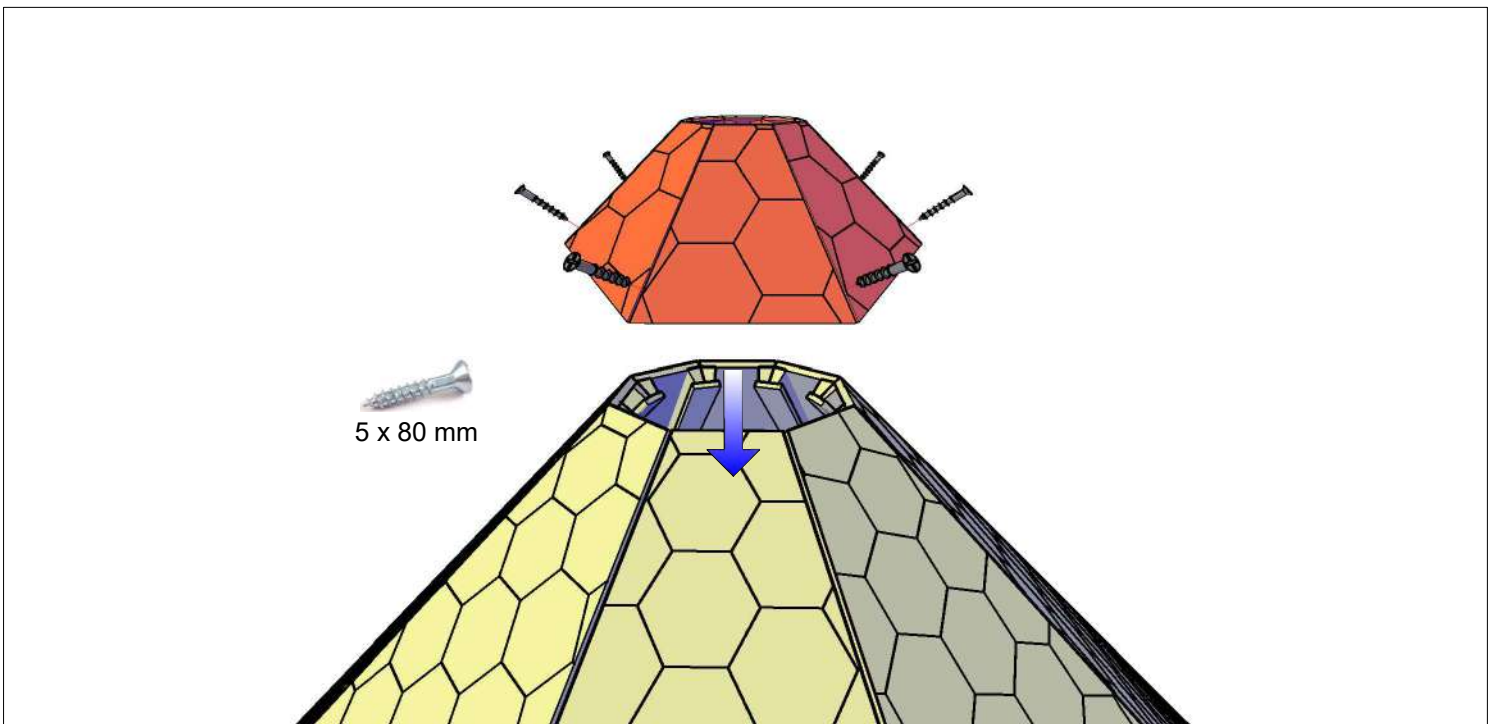
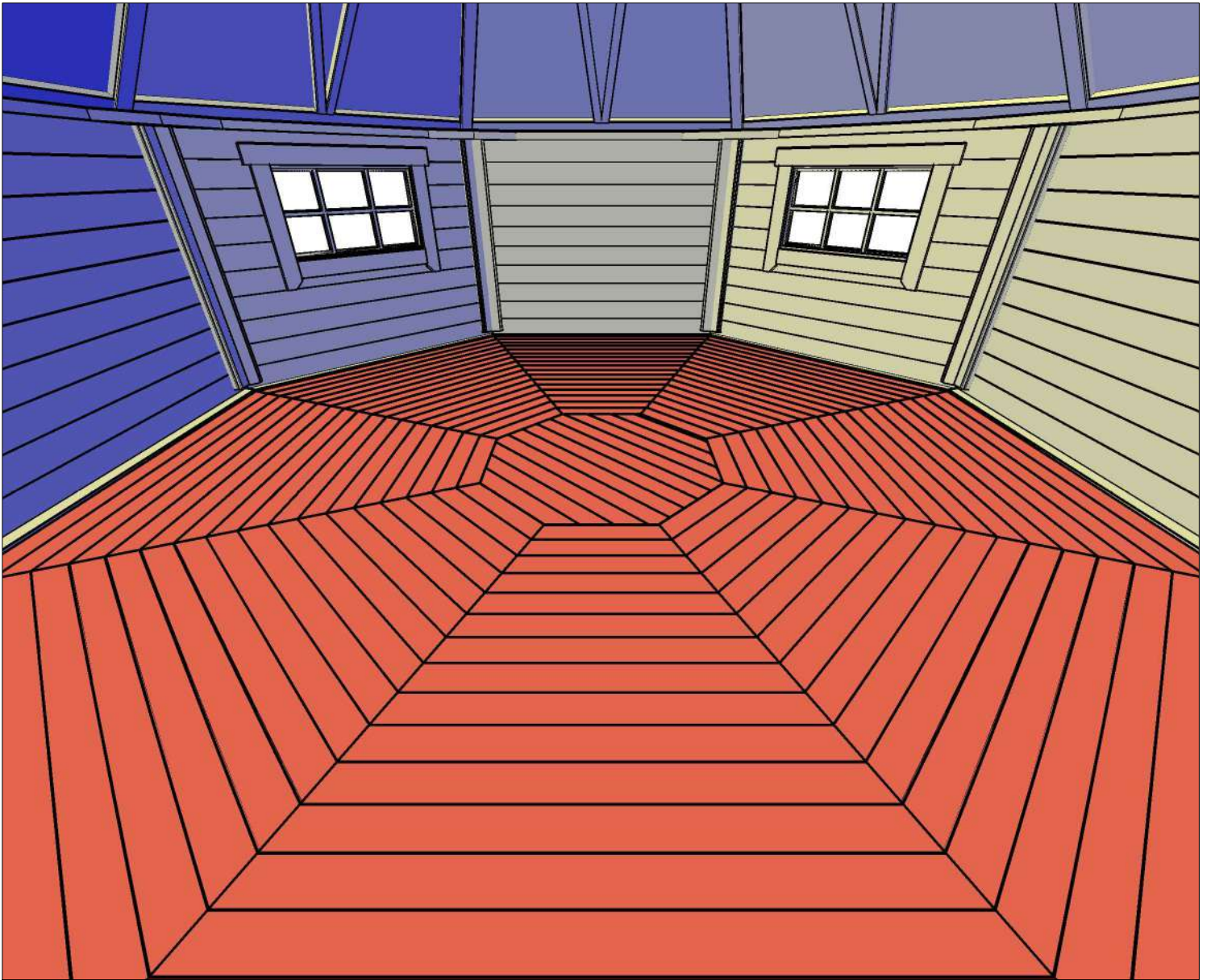

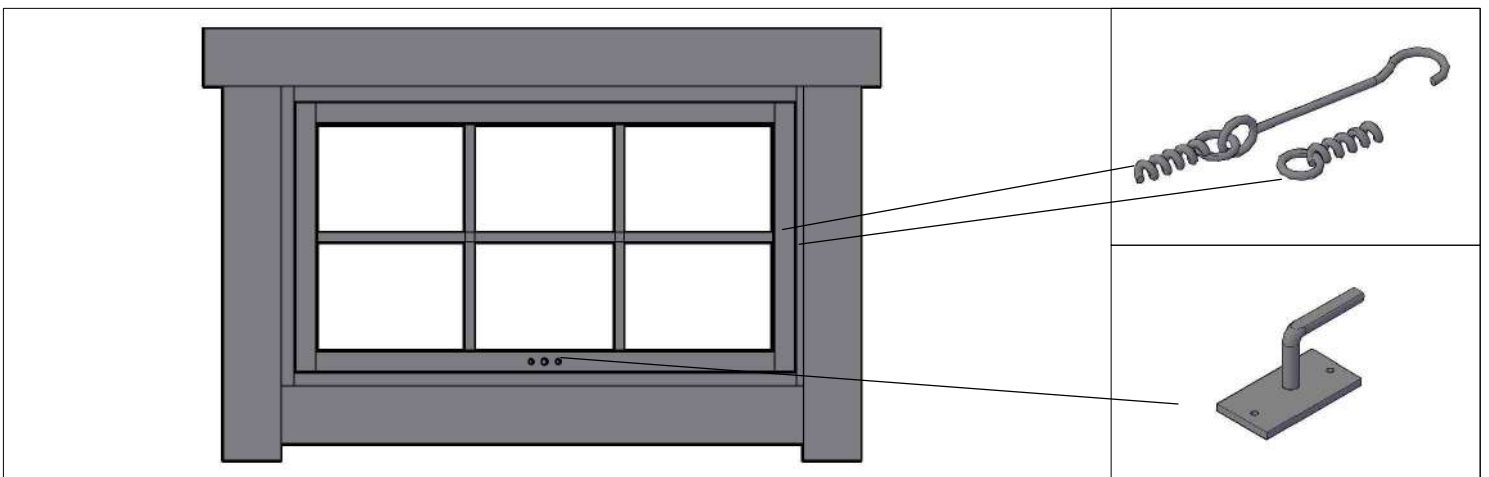
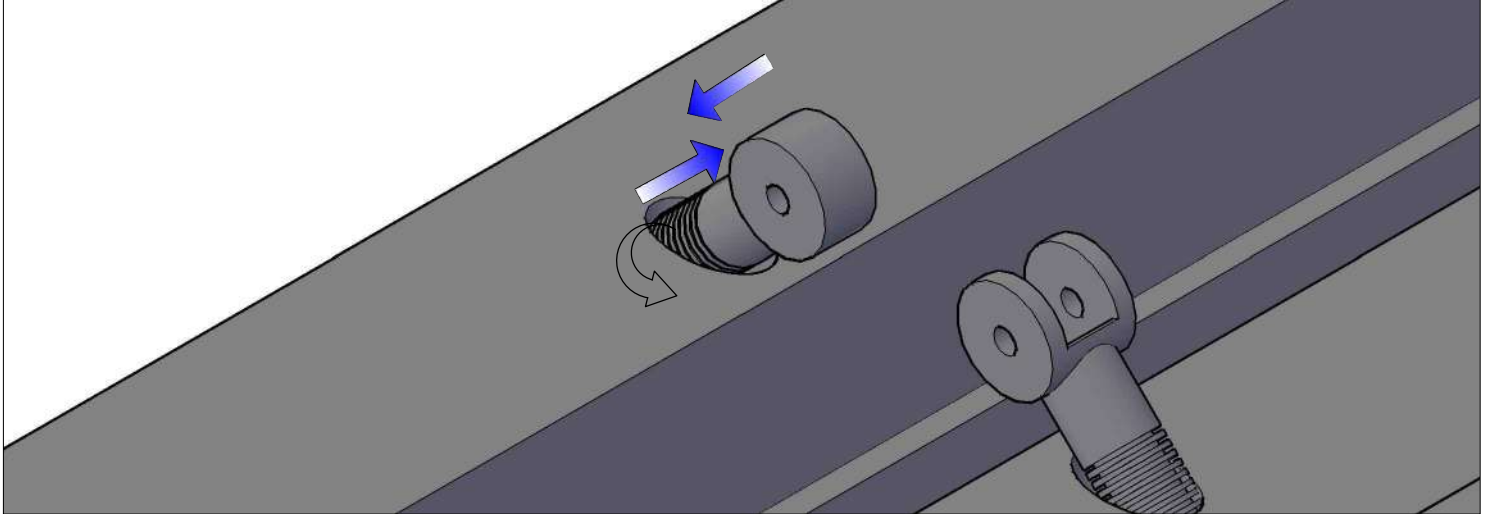
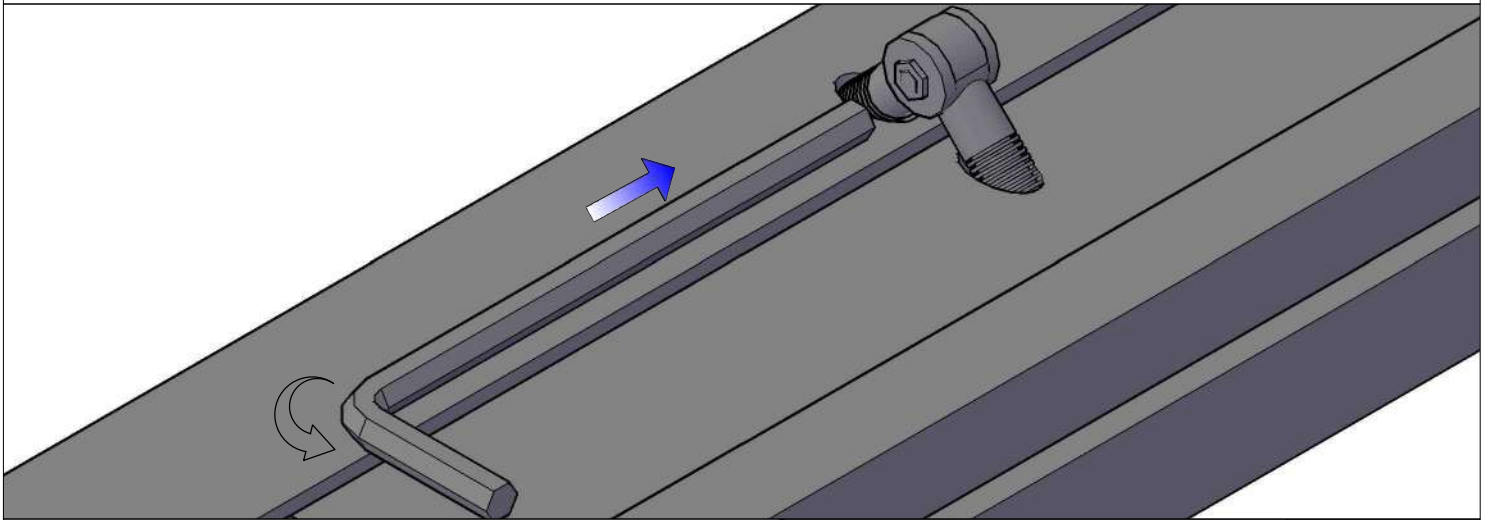
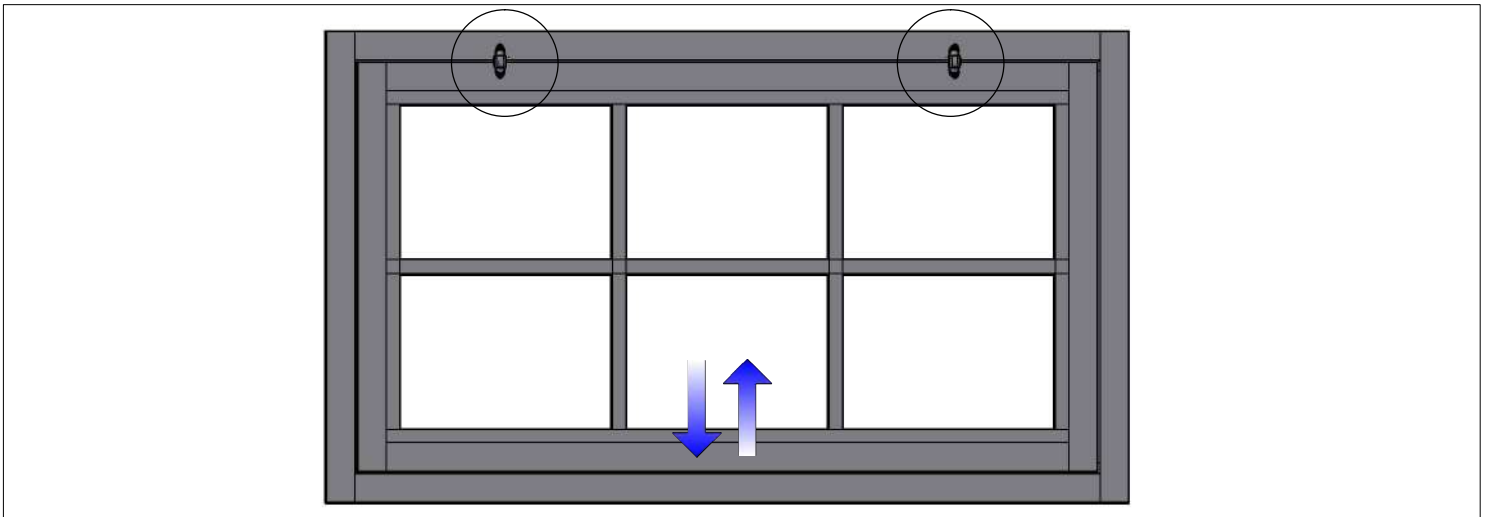

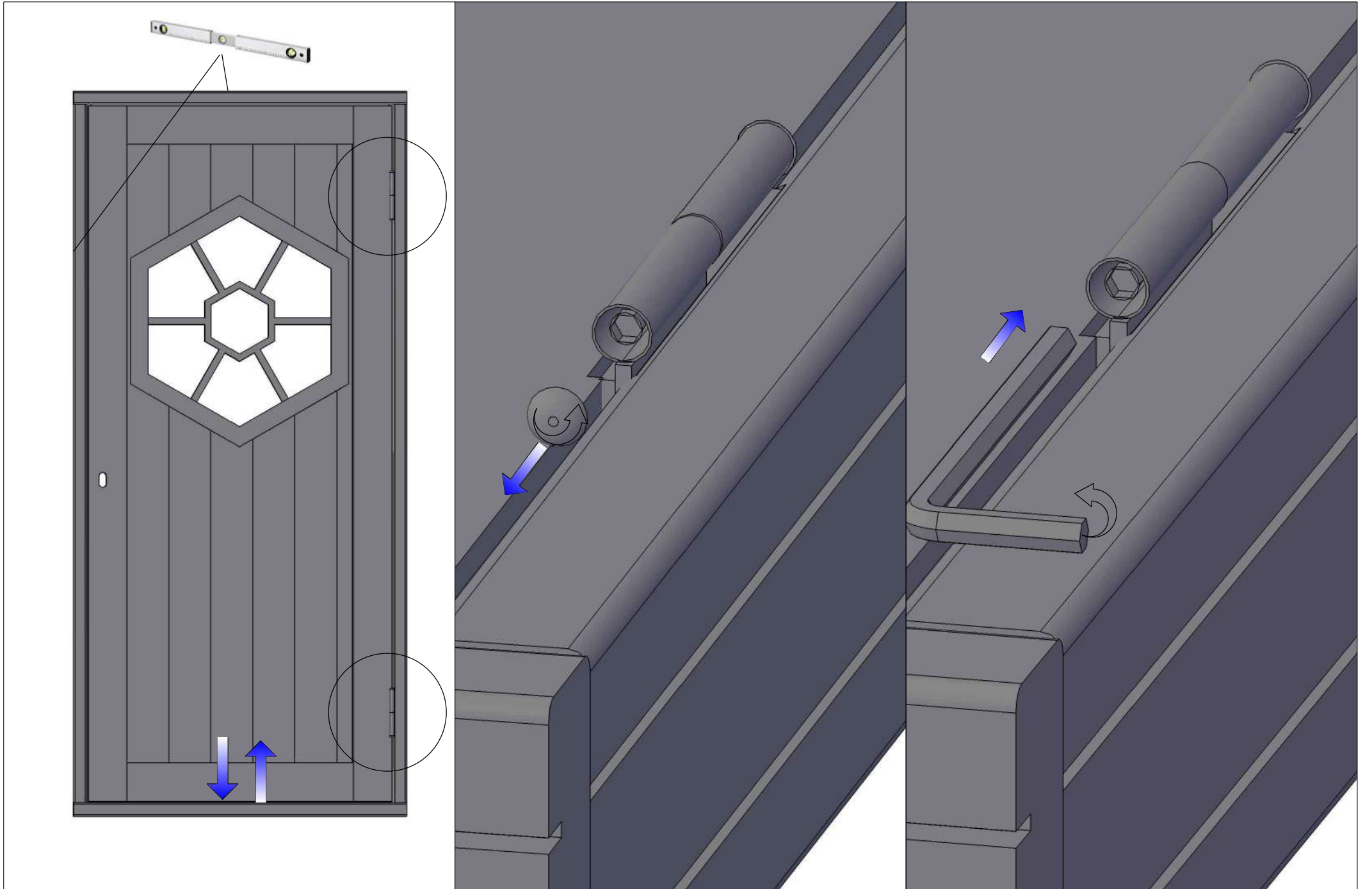

General safety instructions

GENERAL HAZARD WARNING

Failure to comply with the precautions and instructions provided with this grill can result in death, serious bodily injury and property loss or damage from hazards of fire, explosions and burn.

Only persons who can understand and follow the instructions in this manual should use the grill house. If you need assistance or information such as instructions, manual, labels etc. contact the manufacturer or your seller.

WARNING !

Fire, burn, explosion hazard. Use solid combustibles, such as dry wood or charcoal as recommended by the instructions. Never attempt to burn materials which may contain flammable, volatile or airborne combustibles or products such as gasoline, solvents, paint thinner, and dust particles or unknown chemicals.

WARNING !

Never use gasoline or other inappropriate substances to set a fire!

Keep lighter fluids and other fire lighting equipment out of children's reach!

While handling hot cooking plates (lifting, turning), use protective gloves and utilize the wooden handles of the product. Never move, handle or service an operating grill.

Recommended fire starters are natural materials - for example wood chips etc. Avoid burning disposable dishes, plastic, cardboard etc.

Fire produces carbon monoxide fumes, be sure that your smoke collector is working correctly and that you have installed a functioning carbon dioxide alarm.

Steel heats up quickly when used on open fire; do not touch the parts that are not protected by wood.

The maximum height of the flame should not be higher than half way between the smoke hood and the bottom of the fireplace.

Make sure that the fireplace is properly fastened to its base.

Do not lean against the fireplace or smoke hood.

Loose clothing should not be worn while grilling.

Burn only wood or charcoal in the fireplace.

Keep water nearby for flare-ups.

Make sure you have fire-extinguishing equipment at hand and teach also others to use them.

Metal burning ring should always be used when burning wood or charcoal.

After use of grill never leave hot ashes or embers unattended. Never leave children or animals alone in the grill house! NEVER TOUCH ANY METAL SURFACES WHILE THE GRILL IS IN USE!

Do not sleep in a grill house while the fire is on!

FOLLOW THE FIRE SAFETY INSTRUCTIONS!

MAINTENANCE

All Arctic Finland House products should be used according to the Arctic Finland House product manual (this document). All of Arctic Finland House products are made from natural wood and it is customer's responsibility to protect / paint his / hers product against the weather. All the products should be treated as normal wood houses. Products need to be protected from mold and painted so that they will last longer. Customer should also make sure that product's air circulation is working also during winter time. This means that customer should make sure that replacement air pipes are open all year around and that moisture gets out from the product (through smoke pipe). Customer should also make sure that Arctic Finland House's product's roof is not covered by heavy snow. There shall not be more than 20 cm (depth) snow on the roof and smoke pipe should never be covered by snow nor closed manually. This will cause moisture inside product and mold inside structure.

All replacement parts are readily available at your Arctic Finland House Retailers.

LIMITED LIABILITY

Arctic Finland House guarantees this product to be free from defects in materials or workmanship to the original consumer. This guarantee is for the periods herein specified when used under normal and reasonable conditions, one (1) year from the date of original purchase. This warranty does not include the cost of property damage or any inconvenience due to the failure of the product. Nor does it cover damage due to misuse, abuse, accident, or damage resulting from transportation of the product. Nor does it include damage resulting from the commercial use of this product. If the product fails to operate due to a defect in materials or workmanship during the warranty period, the defective part will be repaired or replaced at Arctic Finland House's option. If you wish to obtain performance under this limited warranty, you should contact your Arctic Finland House retailer. The defective part, along with proof of purchase, must be returned postage prepaid to Arctic Finland House retailer. We suggest that you keep your purchase receipt as we may require reasonable proof of purchase. All implied warranties, including the implied warranties of merchantability and fitness for a particular purpose, are limited in duration to the express warranty periods specified herein for the parts described herein.

Neither Arctic Finland House dealers, nor the retail establishment selling this product has any authority to make any warranties or to promise remedies in addition to or inconsistent with those stated above. Arctic Finland House's maximum liability shall not exceed the purchase price of the product paid by the original consumer. Arctic Finland House and the Arctic Finland House logo are registered trademarks of Arctic Finland House.

CAUTION

Accessible parts may be very hot. Keep young children away. • **CARBON MONOXIDE HAZARD-THIS APPLIANCE CAN PRODUCE CARBON MONOXIDE** (no odor). Do not use in enclosed areas, (for example: car, tent, caravan, mobile home) may cause death. This appliance shall only be used in an above ground, with proper ventilation, without stagnant areas, where gas leakage & products of combustion are rapidly dispersed by wind & natural convection. • Use appliance only in horizontal position. • This appliance must only be serviced by an authorized person. • Do not use this appliance if it has damaged or worn seals. • Do not move this appliance during operation.

IF YOU ARE NOT SURE WHAT YOU ARE DOING, CONTACT YOUR CLOSEST ARCTIC FINLAND HOUSE DEALER FOR HELP.